



RED SWASTIKA SCHOOL

2022 PRELIMINARY ASSESSMENT

MATHEMATICS PAPER 1

Name : _____ ()

Class : Primary 6 / _____

Date : 19 August 2022

BOOKLET A

15 Questions

20 Marks

Duration of Paper 1 (Booklets A & B): 1 hour

Note:

1. Do not open this Booklet until you are told to do so.
2. Read carefully the instructions given at the beginning of each part of the Booklet.
3. Do not waste time. If a question is difficult for you, go on to the next one.
4. Check your answers thoroughly and make sure you attempt every question.
5. In this booklet, you should have the following:
 - (a) Page 1 to Page 6
 - (b) Questions 1 to 15
6. You are not allowed to use a calculator.

Questions 1 to 10 carry 1 mark each. Questions 11 to 15 carry 2 marks each. For each question, four options are given. One of them is the correct answer. Make your choice (1, 2, 3 or 4). Shade the correct oval (1, 2, 3 or 4) on the Optical Answer Sheet. (20 marks)

1 Which of the following is fifty-six thousand and three in numerals?

- (1) 5603
- (2) 56 003
- (3) 560 003
- (4) 5 600 003

2 Round off 83.569 to the nearest tenth.

- (1) 80
- (2) 84
- (3) 83.6
- (4) 83.57

3 What is the mass of the wooden block below?

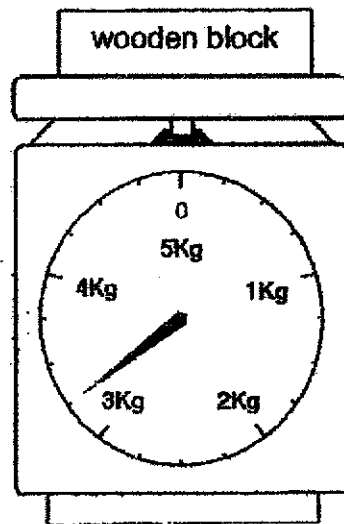

- (1) 3 kg 150 g
- (2) 3 kg 200 g
- (3) 3 kg 250 g
- (4) 3 kg 300 g

4 Express 70 km 8 m in metres.

- (1) 708 m
- (2) 7008 m
- (3) 70 008 m
- (4) 700 008 m

5 What is the area of the shaded triangle?

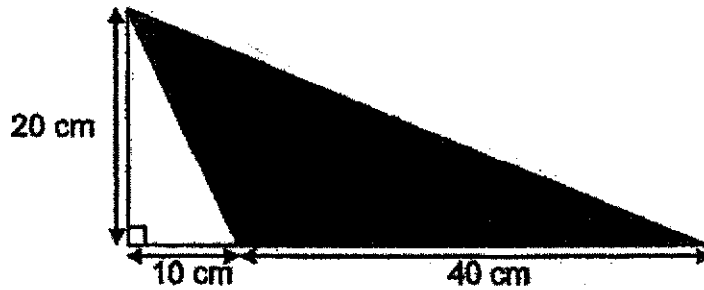

- (1) 100 cm²
- (2) 400 cm²
- (3) 500 cm²
- (4) 800 cm²

6 In the figure, PQ and RS are straight lines.

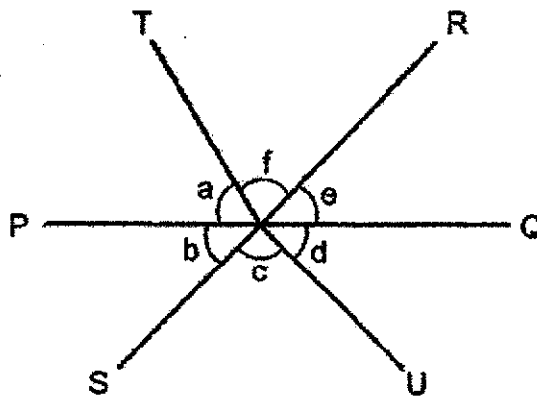

Which one of the following is true?

- (1) $\angle a = \angle d$
- (2) $\angle b = \angle e$
- (3) $\angle a + \angle b = \angle e + \angle d$
- (4) $\angle b + \angle c = \angle e + \angle f$

- 7 The pie chart shows the different types of sandwiches sold at a stall.

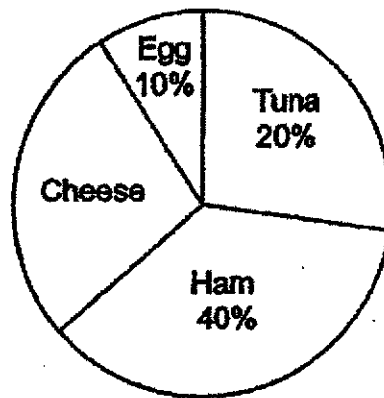

What is the ratio of the number of tuna sandwiches sold to the number of cheese sandwiches sold?

- (1) 2 : 3
(2) 3 : 2
(3) 4 : 5
(4) 5 : 4
- 8 Find the value of $9c - 3 + 2c$ when $c = 7$.
- (1) 28
(2) 46
(3) 67
(4) 74
- 9 Which one of the following fractions is the largest?

- (1) $\frac{2}{3}$
(2) $\frac{2}{5}$
(3) $\frac{3}{8}$
(4) $\frac{5}{8}$

- 10 Vinush has a rectangular piece of paper. He folded it along the dotted line as shown below.

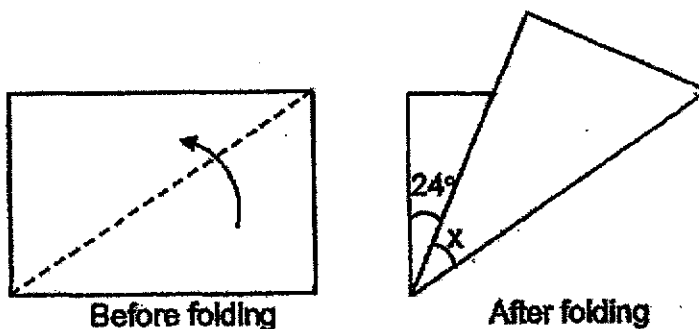

Find $\angle x$.

- (1) 21°
 - (2) 33°
 - (3) 42°
 - (4) 66°
- 11 ABC is a straight line and ABD is an isosceles triangle. $\angle ADB = 70^\circ$ and $DA = DB$.

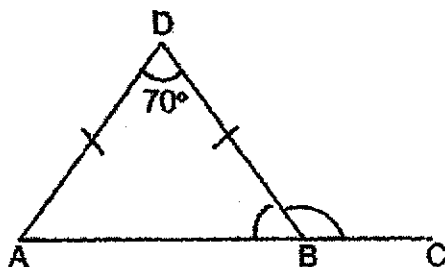

Find $\angle DBC$.

- (1) 110°
- (2) 125°
- (3) 135°
- (4) 140°

- 12 The clock below shows the time Ian reached the cinema.

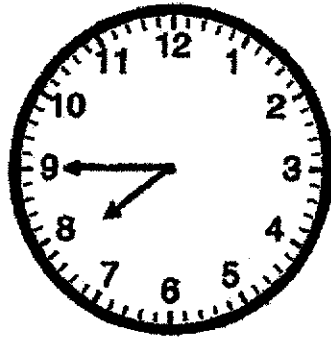

Ian was 10 minutes late for the movie. What time did the movie start?

- (1) 7.35 p.m.
 - (2) 7.55 p.m.
 - (3) 8.35 p.m.
 - (4) 8.55 p.m.
- 13 The table shows the number of books borrowed from a library by the children in a class.

Number of books	0	1	2	3	4
Number of children	3	9	4	8	2

How many children borrowed more than 2 books?

- (1) 10
 - (2) 12
 - (3) 14
 - (4) 16
- 14 Kumar travelled $\frac{1}{3}$ of his journey in 2 h. He then travelled the remaining 240 km at a speed of 80 km/h. Find Kumar's average speed for the whole journey.
- (1) 60 km/h
 - (2) 66 km/h
 - (3) 70 km/h
 - (4) 72 km/h

- 15 Mrs Yati chained some circular white, grey and black beads together in a repeated pattern as shown below. The radius of each bead is 2 cm.

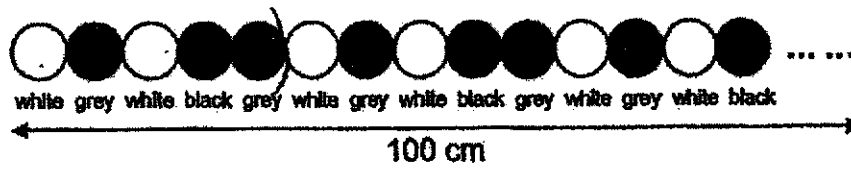

Using the pattern above, Mrs Yati made a 100 cm chain of beads. How many grey beads did she use?

- (1) 5
- (2) 10
- (3) 20
- (4) 40



RED SWASTIKA SCHOOL

2022 PRELIMINARY ASSESSMENT

MATHEMATICS PAPER 1

Name : _____ ()

Class : Primary 6 / _____

Date : 19 August 2022

BOOKLET B

15 Questions
25 Marks

In this booklet, you should have the following:

- (a) Page 7 to Page 13.
- (b) Questions 16 to 30

MARKS

	OBTAINED	POSSIBLE
BOOKLET A		20
BOOKLET B		25
TOTAL		45

Parent's Signature : _____

Questions 16 to 20 carry 1 mark each. Write your answers in the spaces provided. For questions which require units, give your answers in the units stated. (5 marks)

16 Find the value of $30 - 8 + 16 + 4 + 2$.

Ans: _____

17 Measure and write down the size of $\angle m$.



Ans: _____ °

18 Find the average of 17 and 28.

Ans: _____

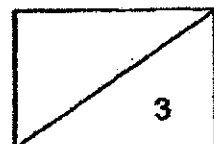

- 19 The figure shows taps A and B with two empty tanks X and Y. The height of both tanks are the same. Both taps are turned on at the same time.

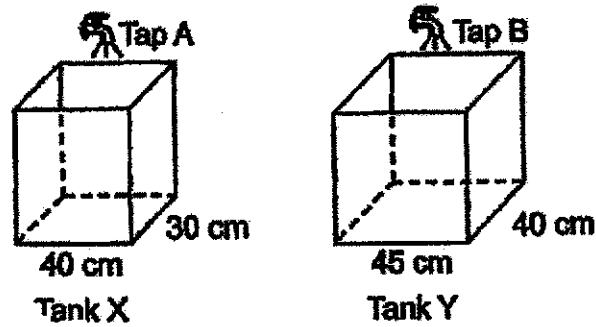

Water flowed from tap A into tank X at a rate of 2 litres per minute. What should the rate of flow of water be from tap B such that the height of water is the same for both tanks after some time?

Ans: _____ l/min

- 20 The figure below is made up of triangles and rectangles. Shade the figure so that the figure has AB as its line of symmetry with $\frac{2}{3}$ of the figure shaded.

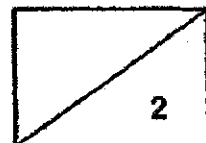
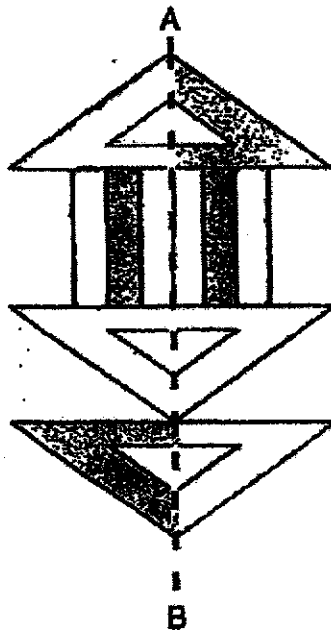

Questions 21 to 30 carry 2 marks each. Show your workings clearly in the space provided for each question and write your answers in the spaces provided. For questions which require units, give your answers in the units stated.

(20 marks)

21 How many sixths are there in $2\frac{1}{3}$?

Ans: _____

22 Mrs Devi poured 8.08 l of water equally into 40 identical containers. How many litres of water did she pour into each container?

Ans: _____ l

23 The perimeter of a square is 36 cm. Find the area of the square.

Ans: _____ cm²

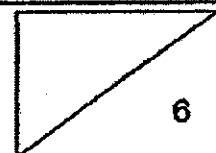

24 Study the solid below.

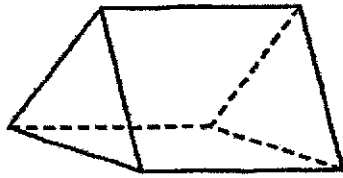

(a) Name the solid.

Ans: _____ [1]

(b) How many triangular and rectangular faces are there in the solid?

Ans: _____ triangular faces and _____ rectangular faces [1]

25 PQR is a right-angled triangle. $\angle QPR = 55^\circ$. Find $\angle x$.

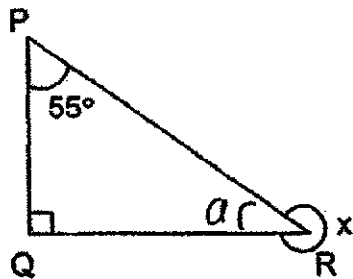

Ans: _____

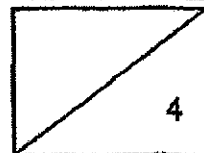

Use the information below to answer Questions 26 and 27.

Aisha received \$80 from her parents each month for her pocket money. After spending, she saved the rest of her money. The line graph below shows the amount of pocket money Aisha spent each month.

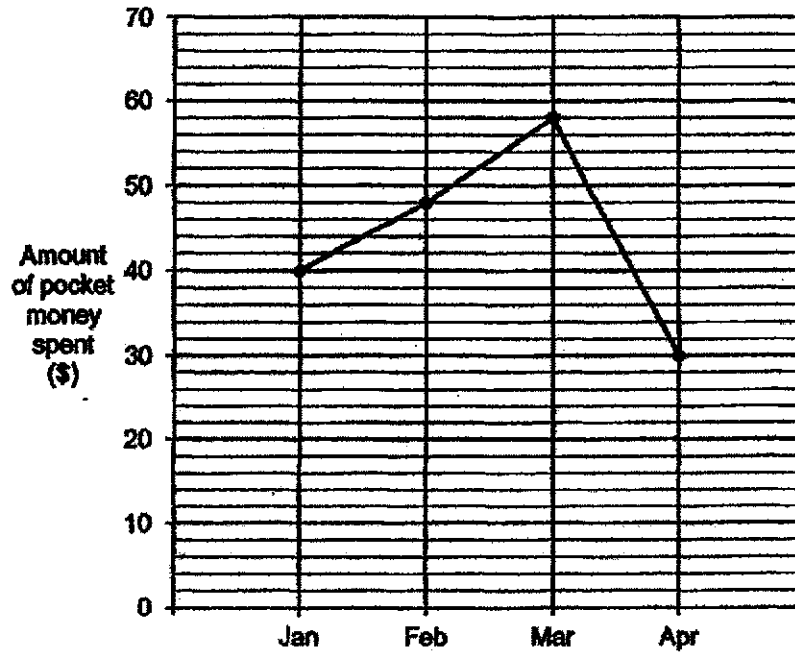

26 How much did Aisha save in February?

Ans: \$ _____

27 In which month did Aisha save the most?

Ans: _____

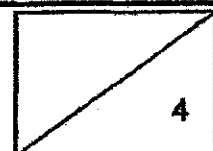

- 28 The table below shows A, B and C which represent three 2-digit numbers. Lydia used two pieces of paper to cover two of the digits in the table. The average of these 3 numbers is 25.

A	15
B	2■
C	■9

What number is represented by C?

Ans: _____

-
- 29 Josh and Ken started cycling from the same place in opposite direction along a straight road. Josh was cycling at 20 km/h and the two boys were 50 km apart after cycling for 90 minutes.

(a) How far did Josh cycle?

Ans: (a) _____ km [1]

- (b) Circle the words that describe Josh and Ken's cycling speed correctly in the following statement:

Ken was cycling (slower than / as fast as / faster than) Josh.

[1]

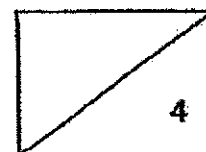

- 30 Mrs Wong placed an equal number of beads into 24 boxes. However, she discovered 4 of her boxes were damaged and she redistributed the beads in these boxes into the remaining 20 boxes. In the end, the number of beads in each of the remaining boxes increases by n . How many beads were there in each box at first? Give your answer in terms of n .

Ans: _____

END OF PAPER

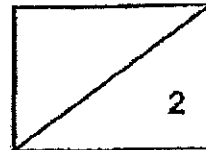



RED SWASTIKA SCHOOL
2022 PRELIMINARY ASSESSMENT
MATHEMATICS
PAPER 2

Name : _____ ()

Class : Primary 6 / _____

Date : 19 August 2022

17 Questions

55 Marks

Duration of Paper 2: 1 hour 30 minutes

Note:

1. Do not open this Booklet until you are told to do so.
2. Read carefully the Instructions given at the beginning of each part of the Booklet.
3. Do not waste time. If a question is difficult for you, go on to the next one.
4. Check your answers thoroughly and make sure you attempt every question.
5. In this paper, you should have the following:
(a) Page 1 to Page 15
(b) Questions 1 to 16
6. You are allowed to use a calculator.

MARKS

	OBTAINED	POSSIBLE
PAPER 1		45
PAPER 2		55
TOTAL		100

Parent's Signature : _____

Questions 1 to 5 carry 2 marks each. Show your workings clearly in the space below each question and write your answers in the spaces provided. For questions which require units, give your answers in the units stated.

(10 marks)

-
- 1 Use all the digits 6, 1, 8, 7 to form
(a) a 4-digit number which has 2 as one of its factors,

Ans: (a) _____ [1]

- (b) a 4-digit number closest to 8000.

Ans: (b) _____ [1]

-
- 2 Dan and Kate had some stickers. When Dan gave 10 of his stickers to Kate, he would have three times as many stickers as Kate. If Dan gives another 6 more stickers to Kate, he would have twice as many stickers as Kate. How many stickers did Kate have at first?

Ans: _____

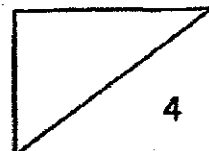

- 3 Kim used two identical rectangles to form the figure as shown below. The perimeter of the figure is 112 cm. Find the perimeter of one rectangle.

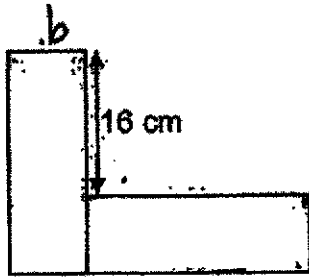

Ans: _____ cm

- 4 Mr Gan bought w bales of cloth to prepare some banners. Each banner is 240 cm in length and none of the banners are made by joining pieces of cloth. Each bale of cloth is 11 m long. What is the maximum number of banners Mr Gan could prepare? Give your answer in terms of w .



1 bale of cloth

Ans: _____

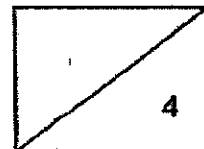

5 The picture below shows part of the seating plan of a classroom.

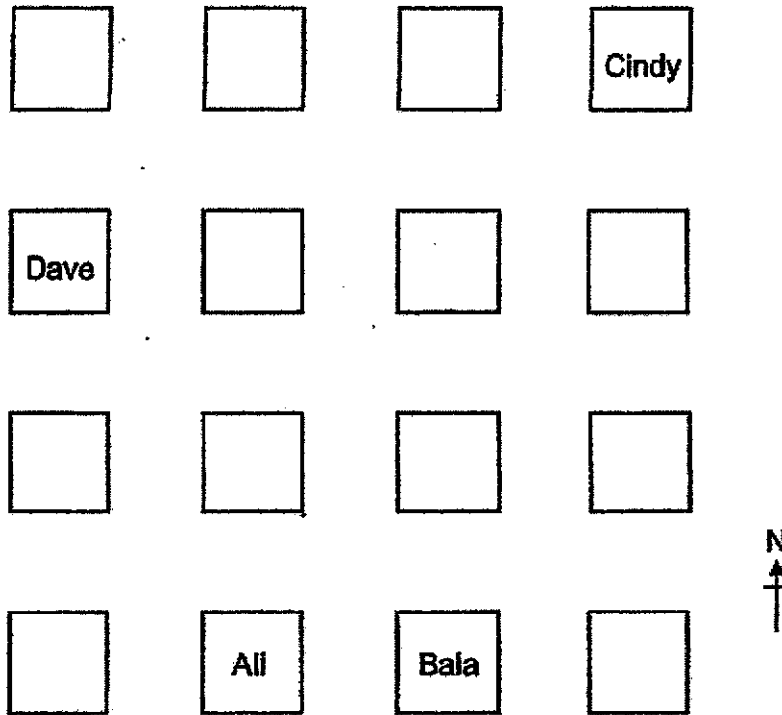

(a) Circle the words that describe Ali and Bala's seating position correctly in the following statement:

Ali is seated (north / south / east / (west)) of Bala.

[1]

(b) Cindy is seated north-east of Xavier and Dave is seated north-west of Xavier. Put a tick (✓) in the square where Xavier is seated.

[1]

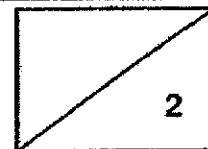

For Questions 6 to 17, show your workings clearly in the space below each question and write your answers in the spaces provided. The number of marks available is shown in brackets [] at the end of each question or part-question.

(45 marks)

-
- 6 A container, $\frac{2}{5}$ filled with sand, weighed 2400 g. After Mindy poured in another 200 cm³ of sand, the container became $\frac{1}{2}$ full.

(a) Find the capacity of the container in cubic centimetres.

Ans:(a) _____ [2]

- (b) Given that the total mass increased by 300 g, find the percentage increase in the total mass.

Ans:(b) _____ [1]

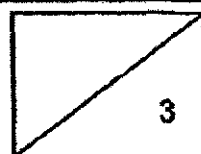

7 Claire went shopping with 12 more ten-dollar notes than two-dollar notes. After paying \$180 for a suitcase with some ten-dollar notes, the number of the two-dollar notes she had was four times the number of ten-dollar notes left.

(a) How many ten-dollar notes did Claire have left?

Ans:(a) _____ [1]

(b) How much money did she have at first?

Ans:(b) _____ [2]

5

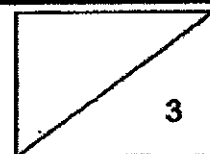

8 Mrs Lee prepared some nuggets and chicken wings for a group of children. The ratio of the number of nuggets prepared to the number of chicken wings prepared was 8 : 3. Each child was given 5 nuggets and 2 chicken wings. There were 9 nuggets left when all the chicken wings were distributed.

(a) How many chicken wings did Mrs Lee prepare?

Ans:(a) _____ [2]

(b) How many children were there in the group?

Ans: (b) _____ [1]

6

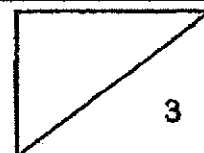

9 At a concert, 60% of the tickets were sold at full price and 35% of the tickets were sold at half price. The remaining 70 tickets were given away free. The total amount of money collected was \$6510.

(a) How many tickets were sold at full price?

Ans:(a) _____ [1]

(b) What was the full price of a ticket?

Ans:(b) _____ [2]

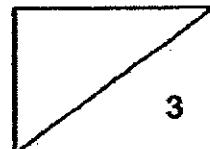

10 Eva builds a solid using 7 unit cubes.

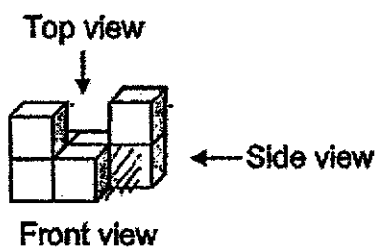

(a) On the square grid below, draw the top and the side view of the solid.

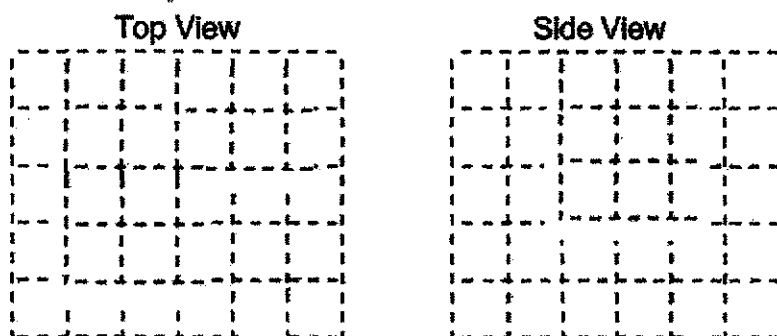

[2]

(b) What is the least number of cubes Eva could add to her solid such that both the top view and side view of her new solid look like Figure X as shown below.

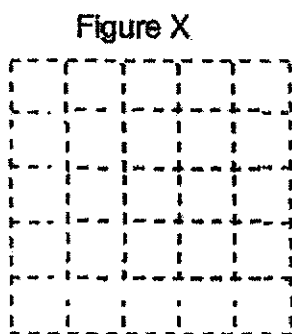

Ans:(b) _____ [1]

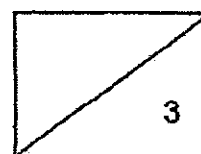

- 11 Eason wanted to make a paper cuboid measuring 20 cm by 6 cm by 4 cm as shown in Figure 1.

Figure 1

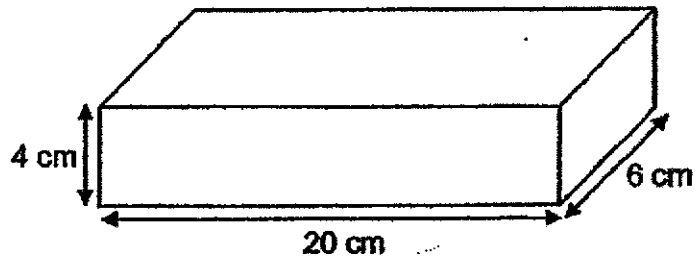

- (a) Find the volume of the cuboid.

Ans:(a) _____ [1]

- (b) Eason drew the net of his cuboid in Figure 2 and it is incorrect. Put a cross 'X' on one face that does not fit the net of his cuboid.

Figure 2

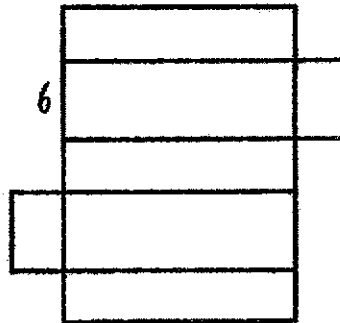

- (c) Find the perimeter of the correct net of his cuboid. [1]

Ans:(c) _____ [2]

- (d) Find the maximum number of 4-cm cubes that can be fitted into his cuboid?,

Ans:(d) _____ [1]

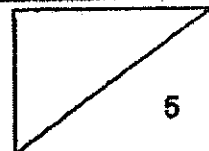

- 12 The bar graphs below show the number of plastic bottles collected by two classes, 6A and 6B, for the week from Monday to Friday. The bar for the number of plastic bottles collected by Class 6B on Friday has not been drawn.

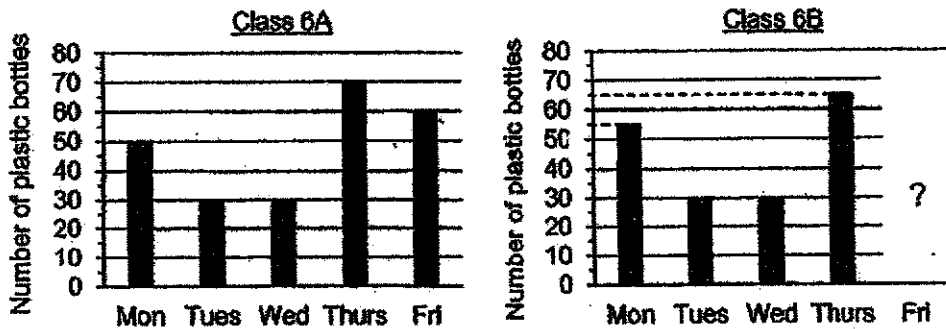

- (a) The number of plastic bottles collected by Class 6B on Friday was $\frac{1}{5}$ the number of plastic bottles collected by the class for the week. How many plastic bottles did Class 6B collect on Friday?

Ans:(a) _____ [2]

- (b) Find the difference in the total number of plastic bottles collected by the two classes over the week.

Ans:(b) _____ [2]

- (c) Stephan drew a pie chart to represent the number of plastic bottles collected over the week by one of the classes, 6A or 6B. However, he had forgotten to label the information in his pie chart.

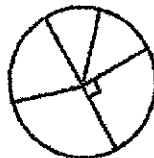

Which class, 6A or 6B, does the pie chart represent?

Ans:(c) _____ [1]

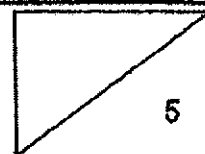

- 13 In the figure below, ABCD and ABDE are rhombuses. CEFG is a square and $\angle DFG = 64^\circ$.

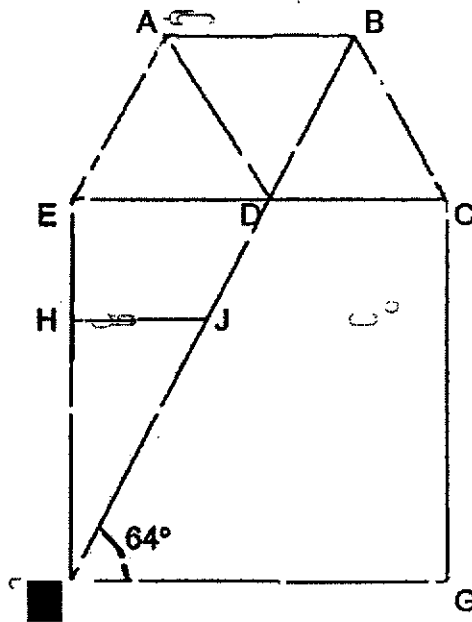

- (a) Find $\angle CDF$.

Ans:(a) _____ [1]

- (b) The figure above is not drawn to scale. Each statement below is either true, false or not possible to tell from the information given above. For each statement, put a tick (\checkmark) to indicate your answer.

Statement	True	False	Not possible to tell
AE is parallel to DF.			
EDJH is a trapezium.			
ABD is an equilateral triangle.			

[2]

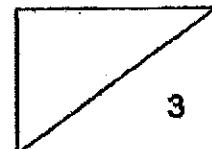

- 14 ABCD is a rectangle with an area of 168 cm^2 . The length of DF is twice that of FC. G is the midpoint of EC.

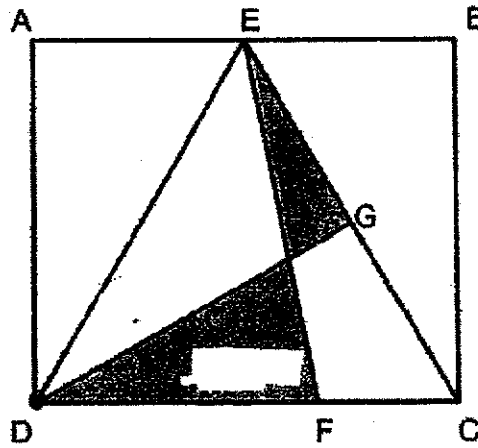

- (a) Find the area of triangle EDC.

Ans:(a) _____ [1]

- (b) Find the difference in the area between the 2 shaded parts.

Ans:(b) _____ [3]

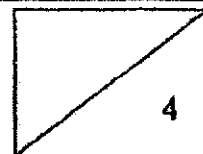

15 Mindy wanted to buy 36 identical pens with her money but she was short of \$7.80. She decided to spend $\frac{4}{7}$ of her money on 15 identical pens and $\frac{1}{2}$ of the remaining money on a ruler.

(a) What fraction of her money did she spend on the ruler?

Ans:(a) _____ [1]

(b) Find the cost of each pen.

Ans:(b) _____ [2]

(c) How much did Mindy have at first?

Ans:(c) _____ [2]

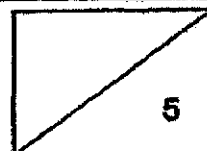

- 16 A rectangle ABCD is drawn on a square grid inside a box. Part of the rectangle is shaded as shown below.

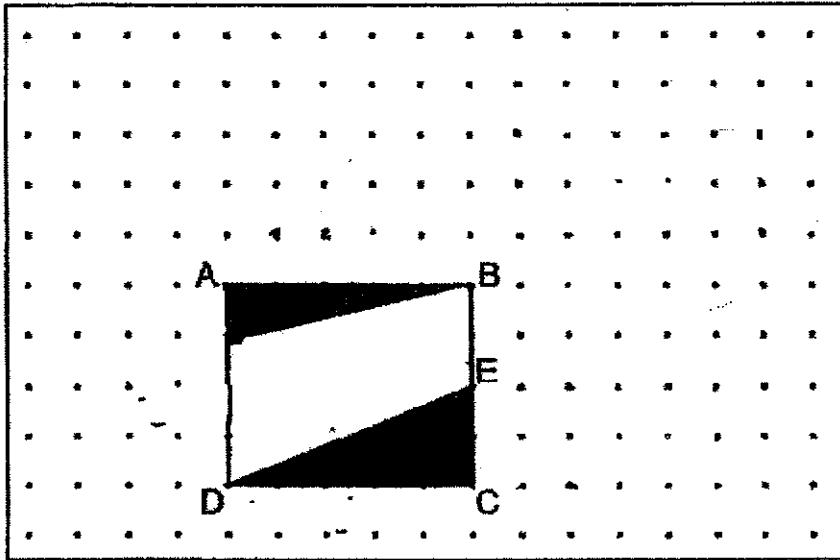

- (a) What is the ratio of the length AB to the perimeter of rectangle ABCD?

Ans:(a) _____ [1]

- (b) What percentage of the rectangle ABCD is shaded?

Ans:(b) _____ [1]

- (c) By joining dots on the grid with straight lines, draw triangle ABX such that the ratio of the area of triangle ABX to the area of rectangle ABCD is 1 : 4 and $\angle XAB$ is an obtuse angle. Triangle ABX must not overlap with rectangle ABCD.

[1]

- (d) By joining dots on the grid with straight lines, draw a trapezium DEFG such that the ratio of the area of triangle CDE to the area of trapezium DEFG is 1 : 3. Trapezium DEFG must not overlap with trapezium ABED.

[1]

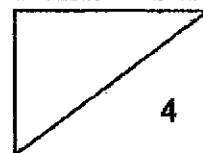

- 17 Shaun drew a three-quarter circle as shown in Figure 1 below. He then cut the three-quarter circle into 3 identical quadrants and arranged them as shown in Figure 2. The perimeter of Figure 2 is 12 cm longer than the perimeter of Figure 1. (Take $\pi = 3.14$)

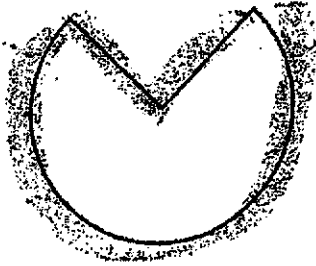

Figure 1



Figure 2

- (a) Find the perimeter of Figure 1.

Ans:(a) _____ [2]

- (b) Find the area of Figure 2.

Ans:(b) _____ [2]

END OF PAPER

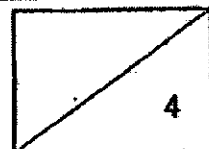

SCHOOL : RED SWASTIKA PRIMARY
 LEVEL : SCHOOL PRIMARY 6
 SUBJECT : MATH
 TERM : Prelims (SA2) 2022

PAPER 1 BOOKLET A

Q 1	Q2	Q3	Q4	Q5	Q6	Q7	Q8	Q9	Q10
2	3	3	3	2	2	1	4	1	2

Q 11	Q12	Q13	Q14	Q15
2	1	1	4	2



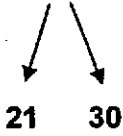

PAPER 1 BOOKLET B

Q16)	$30 - 8 + 16 \div 4 + 2$ $= 30 - 8 + 4 + 2$ $= 22 + 4 + 2$ $= 28$
Q17	130°
Q18	$\frac{17 + 28}{2} = 22.5$
Q19	3
Q20	
Q21	$2\frac{1}{3} \div \frac{1}{6} = \frac{7}{3} \times \frac{6}{1}$ $= \frac{42}{3}$ $= 14$
Q22	$8.08 \div 40$

	$= 8.08 \div 4 \div 10$ $= 2.02 \div 10$ $= 0.202$
Q23	$\frac{36}{4} = 9$ $9 \times 9 =$ 81cm^2
Q24	a) Prism b) 2 Triangular faces and 3 rectangular faces
Q25	$\angle a = 180^\circ - 90^\circ - 55^\circ = 35$ $\angle x = 360^\circ - 35^\circ$ $= 325^\circ$
Q26	$80 - 48 = 32$
Q27	April
Q28	$25 \times 3 = 75$ $75 - 15 = 60$ $60 - 9 = 51$  $30 + 9 = 39$
Q29	a) $90\text{min} = 1\text{hour } 30\text{ mins} = 1\frac{1}{2}\text{ hours}$ $20 \times 1\frac{1}{2} = 30$ 30km b) Ken was cycling slower than Josh. Working: $50 - 30 = 20$
Q30	$20 \times n = 20n$ $20n = 4\text{box}$ $1\text{ box} = 20n \div 4$ $= 5n$

PAPER 2

Q1	a) $1786 = 893 \times 2$ Answer = 1786 b) 7861
Q2	$4U + 40 = 3U + 48$

	$4U - 3U = 48 - 40$ $= 8$
Q3	$6b + 16 \times 4 = 112$ $6b = 112 - 64 = 48$ $b = 48 \div 6 = 8$ $8 \times 4 = 32$ $32 + 16 + 16 = 64$ ans: 64cm
Q4	$240\text{cm} = 2.4\text{m}$ $11/(2.4) \approx 4$ $4 \times w = 4w$
Q5	<p>a) Ali is seated west of Bala</p>     <p>b)</p>
Q6	<p>a) $\frac{1}{2} - \frac{2}{5} = \frac{1}{10}$ $1U = 200$ $10U = 200 \times 10 = 2000\text{cm}^3$</p> <p>b) $\frac{300}{2400} \times 100 = 12.5\%$</p>
Q7	<p>a) $\frac{180}{10} = 18$ $18 - 12 = 16$ $4U - 1U = 3U$ $3U = 6$ $1U = \frac{6}{3} = 2$ Answer: 2</p> <p>b) \$2: $2 \times 4 = 8$ & $8 \times 2 = 16$</p> <p>\$10= $180 + 2 \times 10 = 200$</p> <p>200 + 16 = 216</p>

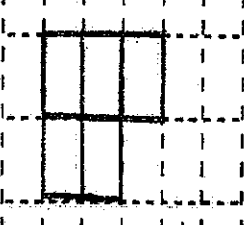
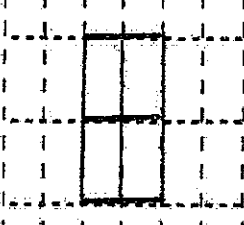
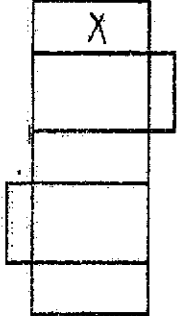
Q8	<p>a) $16U - 15U = 1U$ $1U = 9$ $6U = 9 \times 6 = 54$</p> <p>b) $\frac{144-9}{5} = 27$ Answer: 27</p>
Q9	<p>$100U - 60U - 39U = 5U$ $5U = 70$ $1U = \frac{70}{5} = 14$ $60 \times 14 = 840$</p> <p>$\frac{35 \times 14}{2} = 245$ $245 + 840 = 1085$ $\frac{6510}{1085} = 6$</p>
Q10	<div style="display: flex; justify-content: space-around; align-items: center;">   </div> <p>a) b) $1+4+3=8$</p>
Q11	<p>a) $6 \times 20 \times 4 = 480\text{cm}^3$</p> <div style="text-align: center;">  </div> <p>b) c) $4+20+4=28$ $20 \times 2 = 40$ $28 \times 2 = 56$ $56 + 40 = 96\text{cm}$ $(20+4+6+4+4+6+4) \times 2 = 96\text{cm}$</p> <p>d) $20 \div 4 = 5$ $4 \div 4 = 1$ $6 \div 4 = 1\text{r}^2$ $5 \times 1 \times 1 = 5$</p>
Q12	<p>a) $\frac{55+30+30+65}{4} = 45$</p>

	<p>b) $50 + 30 + 30 + 70 + 60 = 240$ $45 \times 5 = 225$ $240 - 225 = 15$</p> <p>c) 6A</p> <p>Working:</p> <p>$A = \frac{240}{4} = 60$ (correct)</p> <p>$B = \frac{225}{4} = 56.25$ (wrong)</p>
Q13	<p>a) $\angle CDF = 180^\circ - 64^\circ = 116^\circ$</p> <p>b) AE is parallel to DF = False EDJH is a trapezium = Not possible to tell ABD is an equilateral triangle = True</p>
Q14	<p>a) $\frac{168}{2} = 84cm^2$</p> <p>b) $\frac{84}{2} = 42$ $\frac{84}{3} \times 2 = 56$ $56 - 42 = 14cm^2$</p>
Q15	<p>a) $\frac{3}{14}$</p> <p>b) $15P = \frac{4}{7} \text{ money}$ $1P = \frac{4}{7} \div 15 = \frac{4}{105} \text{ Money}$ $36P = \frac{4}{105} \times 36 = 1\frac{13}{35}$ $13U = 7.8$ $35u = \frac{7.8}{13} \times 35 = 21$ $21 \div 7 \times 4 = 12$ $\frac{12}{15} = 0.8$ \$0.80</p> <p>c) $\frac{12}{8} \times 14 = 21$ \$21</p>
Q16	<p>a) $5 + 5 + 4 + 4 = 18$ Ans: 5:18</p> <p>b) $5 \times 4 = 20$ $\frac{1}{2} \times 5 \times 1 = 2.5$ $\frac{1}{2} \times 2 \times 5 = 5$ $\frac{2.5 + 5}{20} \times 100 = 37.5$ 37.5%</p>

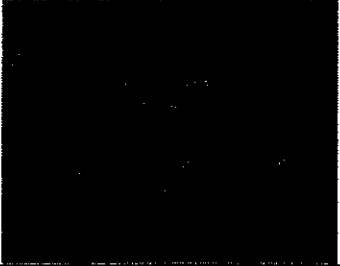
	<p>c) . d) .</p> 
Q17	<p>a) $\frac{12}{2} = 6$ $d = 6 \times 2 = 12$ $12 \times 3.14 \times \frac{3}{4} = 28.26$ $28.26 + 12 = 40.26$ 40.26cm</p> <p>b) $6 \times 6 \times 3.14 \times \frac{3}{4} = 84.78$ 84.78cm²</p>