

CATHOLIC HIGH SCHOOL
PRELIMINARY EXAMINATION (2023)
PRIMARY SIX
MATHEMATICS
PAPER 1
(BOOKLET A)

Name : _____ ()

Class : Primary 6 _____

Date : 22 August 2023

Total time for Booklet A and B : 1 hour

15 questions

20 marks

Parent's signature : _____

INSTRUCTIONS TO CANDIDATES

Do not turn over this page until you are told to do so.

Follow all instructions carefully.

Answer all questions.

Shade your answers in the Optical Answer Sheet (OAS) provided.

The use of calculators is **NOT** allowed.

This booklet consists of 8 printed pages.

Questions 1 to 10 carry 1 mark each. Questions 11 to 15 carry 2 marks each. For each question, four options are given. One of them is the correct answer. Make your choice (1, 2, 3 or 4). Shade the oval (1, 2, 3 or 4) on the Optical Answer Sheet. All diagrams are not drawn to scale. (20 marks)

1. Which of the following is five hundred and sixty-seven thousand and thirty in numerals?

- (1) 56 730
 - (2) 67 530
 - (3) 567 030
 - (4) 670 530
-

2. What is the value of $3 \div 600$?

- (1) 50
 - (2) 200
 - (3) 0.02
 - (4) 0.005
-

3. What is a possible length of a badminton court in a school?

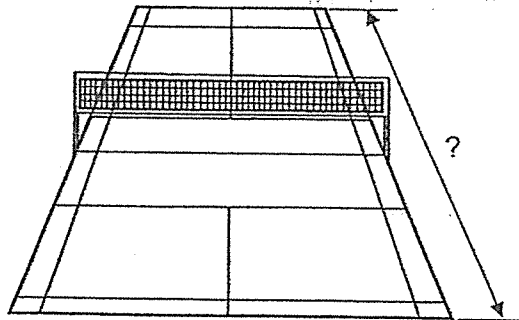

- (1) 13.4 cm
 - (2) 13.4 m
 - (3) 134 cm
 - (4) 134 m
-

4. Which of the following shows 25% of the figure shaded?

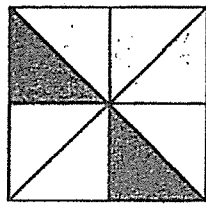

(1)

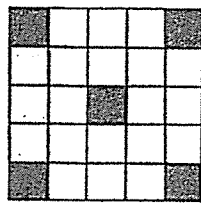

(2)

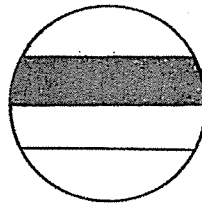

(3)

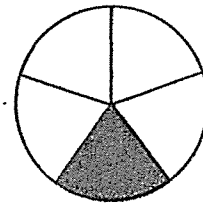

(4)

-
5. In the number line, what is the value represented by X?

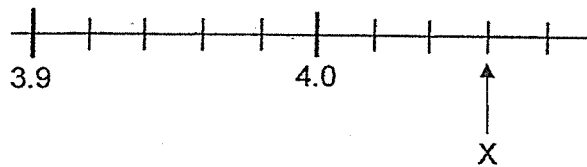

- (1) 4.03
(2) 4.06
(3) 4.3
(4) 4.6

-
6. A cut along the diameter of a circular paper will obtain 2 equal pieces. How many such cuts along the diameter must be made to obtain 16 smaller pieces of equal size?

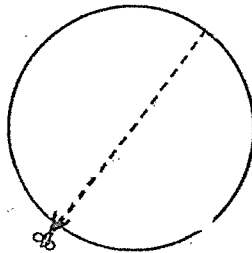

- (1) 16
(2) 15
(3) 8
(4) 4

7. A, B, C and D are points on a square grid. Which point when joined to Y forms a line that is perpendicular to XY?

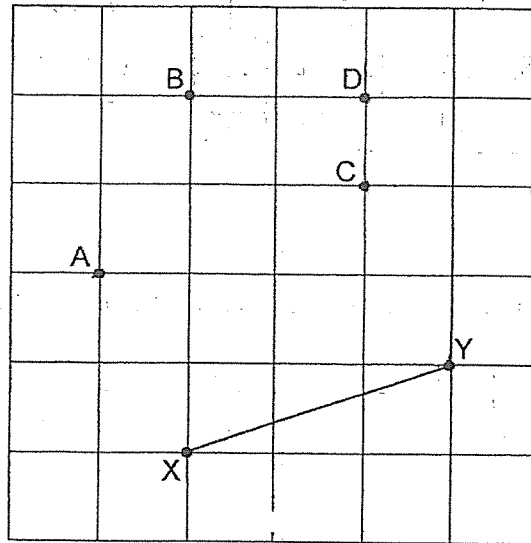

- (1) A
 (2) B
 (3) C
 (4) D

8. In the figure, QR and ST are straight lines. Find $\angle m$.

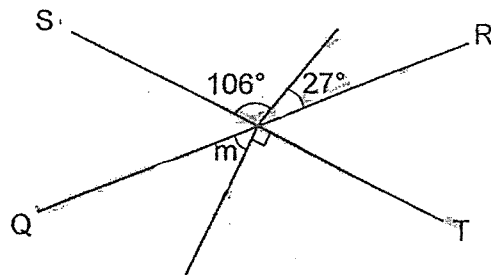

- (1) 16°
 (2) 27°
 (3) 43°
 (4) 47°

9. The bar graph shows the number of cakes baked by a bakery over four months. The number of cakes baked is not shown on the graph.

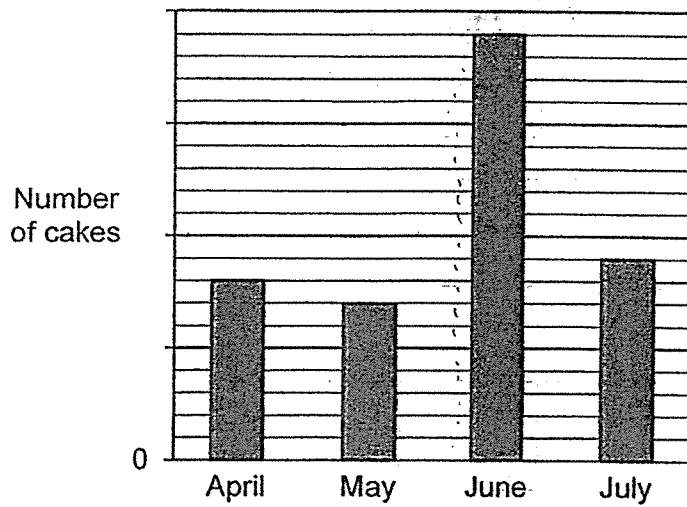

Which of the following table represents the bar graph above?

Month	Number of cakes
April	80
May	70
June	190
July	90

(1)

Month	Number of cakes
April	70
May	60
June	190
July	90

(2)

Month	Number of cakes
April	80
May	70
June	180
July	90

(3)

Month	Number of cakes
April	70
May	60
June	180
July	80

(4)

10. Which of the following is not the net of the cuboid?

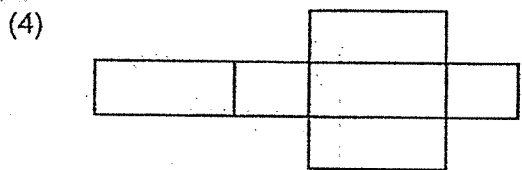
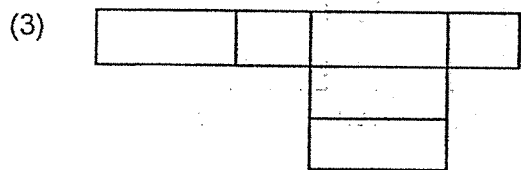
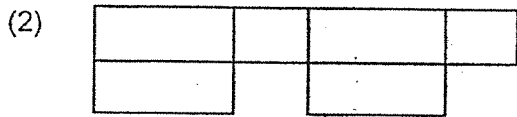
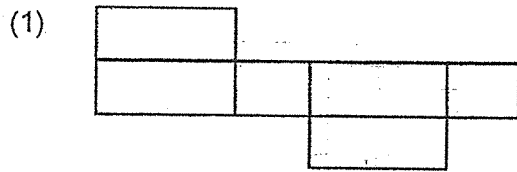

11. Arrange these volumes from the largest to the smallest.

2.35ℓ	$2 \ell 305 \text{ ml}$	$2\frac{3}{5} \ell$
-------------	-------------------------	---------------------

	<u>Largest</u>		<u>Smallest</u>
(1)	$2\frac{3}{5} \ell$	2.35ℓ	$2 \ell 305 \text{ ml}$
(2)	$2\frac{3}{5} \ell$	$2 \ell 305 \text{ ml}$	2.35ℓ
(3)	2.35ℓ	$2\frac{3}{5} \ell$	$2 \ell 305 \text{ ml}$
(4)	$2 \ell 305 \text{ ml}$	2.35ℓ	$2\frac{3}{5} \ell$

12. Walter packed $\frac{4}{5}$ kg of flour into as many bags of $\frac{1}{4}$ kg as possible and had some flour left. What was the mass of the flour left?

(1) $\frac{1}{5}$ kg

(2) $\frac{2}{5}$ kg

(3) $\frac{1}{20}$ kg

(4) $\frac{11}{20}$ kg

13. Jean had some tickets to sell. After selling 56 of them in the morning and $\frac{4}{7}$ of the remainder in the afternoon, she was left with $\frac{1}{5}$ of the tickets. How many tickets were sold altogether?

(1) 77

(2) 84

(3) 88

(4) 105

14. After a 20% discount, the price of a T-shirt was \$40. A first-time customer was given a further discount of \$6. What was the total percentage discount given to a first-time customer for the T-shirt?

(1) 16%

(2) 26%

(3) 32%

(4) 40%

15. In the figure, ABCD is a rectangle made up of four triangles.
The ratio of the area of triangle ABF to that of the rectangle is 1 : 9.
The ratio of the area of triangle AFE to that of the rectangle is 1 : 6.

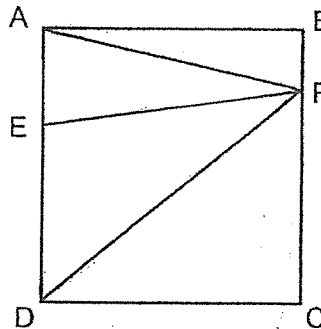

Which of the following statement(s) is/are true?

- Statement A : The ratio of the area of triangle ABF to that of triangle AFE is 2 : 3.
- Statement B : ED is the base of triangle EFD and its corresponding height is EF
- Statement C : The sum of the area of triangles ABF and DEC is equal to the sum of the area of triangles AFE and EFD.

- (1) A only
- (2) B only
- (3) A and C only
- (4) B and C only

END OF BOOKLET A

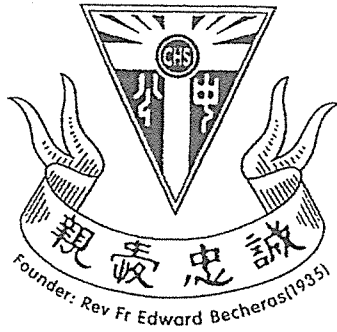

CATHOLIC HIGH SCHOOL
PRELIMINARY EXAMINATION (2023)
PRIMARY SIX
MATHEMATICS
PAPER 1
(BOOKLET B)

Name : _____ ()

Class : Primary 6 _____

Date : 22 August 2023

Total time for Booklet A and B : 1 hour

15 questions

25 marks

Parent's signature : _____

BOOKLET A	20
BOOKLET B	25
Total Marks	45

INSTRUCTIONS TO CANDIDATES

Do not turn over this page until you are told to do so.

Follow all instructions carefully.

Answer all questions.

Write your answers in this booklet.

The use of calculators is **NOT** allowed.

This booklet consists of 9 printed pages and 1 blank page.

Questions 16 to 20 carry 1 mark each. Write your answers in the spaces provided. For questions which require units, give your answers in the units stated. All diagrams are not drawn to scale. (5 marks)

Do not write in this space

16. Round 43.558 to the nearest tenth.

Ans: _____

17. Find the value of 1.58×70

Ans: _____

18. Find the value of $\frac{3}{5} \div 18$
Give your answer as a fraction in the simplest form.

Ans: _____

19. The table shows the start and the end time of two radio programmes on the same day.

Do not write in this space

Programme	Start time	End time
A	10.45 a.m.	12.20 p.m.
B	5.20 p.m.	?

Programme B is 20 minutes shorter than Programme A. At what time does Programme B end?

Ans: _____ p.m.

20. The figure is made up of 16 identical squares. There are 5 shaded squares in the figure. Shade 3 more squares to form a symmetric figure with AB as the line of symmetry.

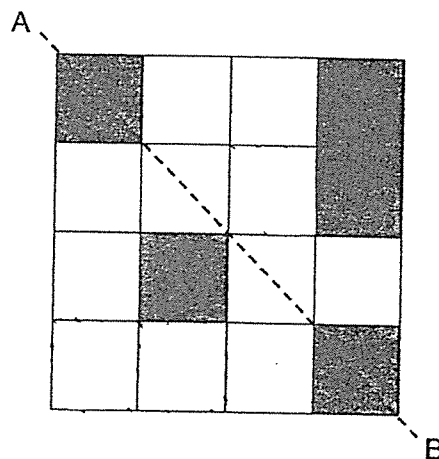

Total marks for questions 16 to 20

3

(Go on to the next page)

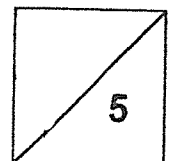

Questions 21 to 30 carry 2 marks each. Show your working clearly and write your answers in the spaces provided. For questions which require units, give your answers in the units stated. All diagrams are not drawn to scale. (20 marks)

Do not write in this space

21.

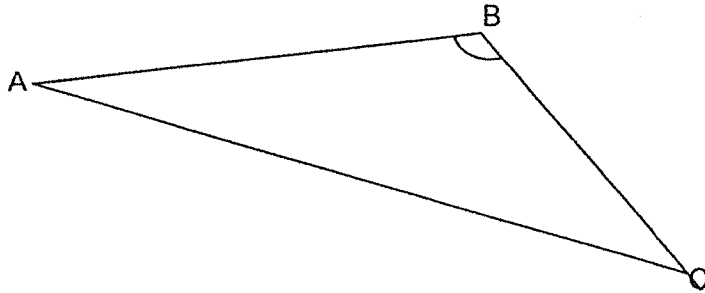

Measure and write down

(a) the length of AC.

Ans: (a) _____ cm

(b) the size of $\angle ABC$.

Ans: (b) _____ °

22. Hui Min folded $(5p + 2)$ paper cranes on Thursday. She folded p more paper cranes on Friday. How many paper cranes did she fold altogether for the 2 days? Give your answer in terms of p in the simplest form.

Ans: _____

23. The table shows the charges for a cleaning job.

First 2 hours	\$35 per hour
Every additional hour	\$25

Mandy paid \$145 for a cleaning job. How many hours of cleaning did she pay for?

Ans: _____ h

Do not write
in this space

24. Triangle QRT is drawn on a square grid.

- (a) Using the lines PQ and QR, draw a parallelogram PQRS.
(b) What fraction of the area of parallelogram PQRS is the area of triangle QRT?

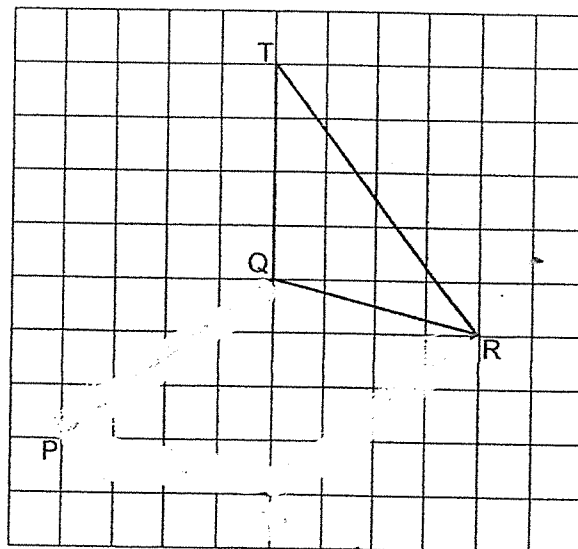

Ans: (b) _____

25. The graph shows the number of pages printed by a printer over 7 minutes.

Do not write
in this space

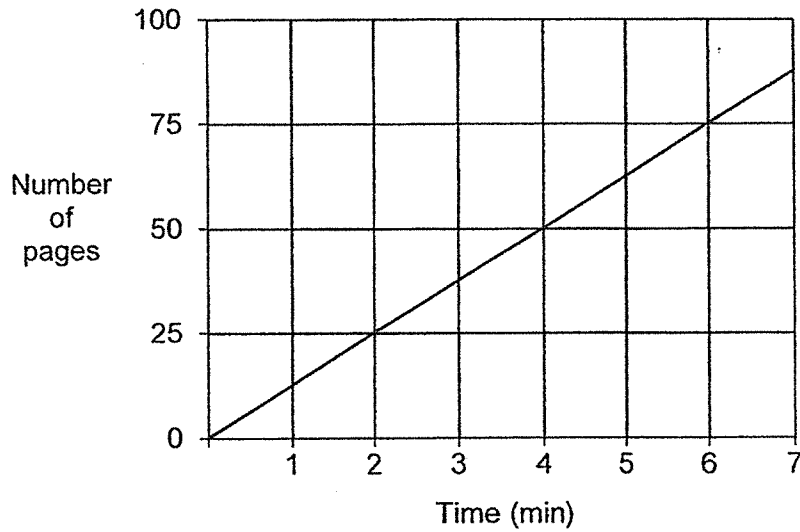

At this rate, how many pages will the printer print in 20 minutes?

Ans: _____

26. The difference between two whole numbers is 45. One of them is a 2-digit number and the other is a 3-digit number. What is the smallest possible sum of the two numbers?

Ans: _____

27. John builds a solid using 8 unit cubes.

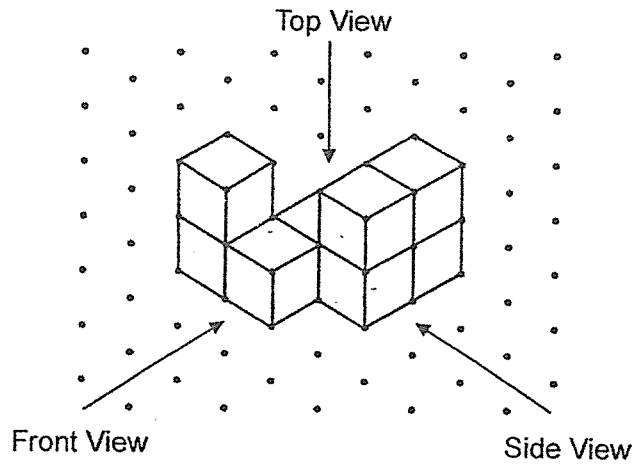

Do not write
in this space

(a) Draw the top view on the grid.

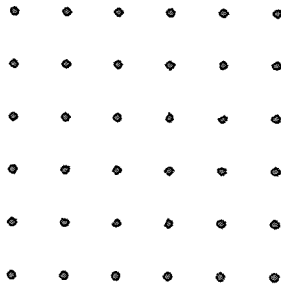

(b) Find the greatest number of unit cubes John can add to the solid without changing the front view and side view of the solid.

Ans: (b) _____

28. Cheryl had three more 50¢ coins than \$1 coins at first. She paid \$2.50 for a pen using 3 coins.

Do not write in this space

Each statement is either true, false or not possible to tell from the information given. Put a tick (✓) to indicate your answer.

Statement	True	False	Not possible to tell
(a) The total value of the \$1 coins was more than the total value of the 50¢ coins at first.			
(b) Cheryl had four more 50¢ coins than \$1 coins after paying for the pen.			

29. Batteries were sold in packs of 9 batteries and 5 batteries. Adam bought 12 packs with a total 88 batteries. How many packs of 5 batteries did Adam buy?

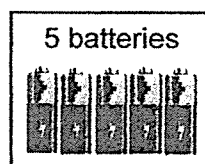
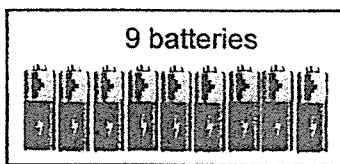

Ans: _____

30. Mr Lim packed 284 eggs on large trays and small trays to sell. He filled each large tray with 8 eggs and each small tray with 5 eggs. All the trays were full and there was no egg left over.

Do not write
in this space



What was the least total number of trays used by Mr Lim?

Ans: _____

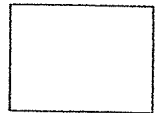

Total marks for questions 21 to 30,

END OF BOOKLET B
END OF PAPER 1

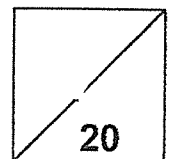

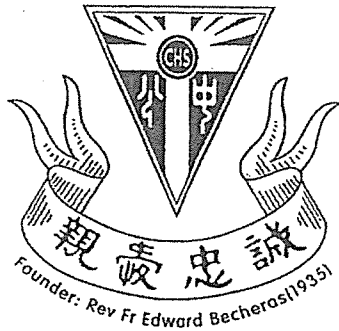

CATHOLIC HIGH SCHOOL
PRELIMINARY EXAMINATION (2023)
PRIMARY SIX
MATHEMATICS
PAPER 2

Name : _____ ()

Class : Primary 6 _____

Date : 22 August 2023

Total time : 1 hour 30 min

17 questions

55 marks

Parent's signature : _____

PAPER 1 BOOKLET A	20
PAPER 1 BOOKLET B	25
PAPER 2	55
Total Marks	100

INSTRUCTIONS TO CANDIDATES

Do not turn over this page until you are told to do so.

Follow all instructions carefully.

Answer all questions.

Write your answers in this booklet.

The use of an approved calculator is expected, where appropriate.

This booklet consists of 16 printed pages and 1 blank page.

Questions 1 to 5 carry 2 marks each. Show your working clearly in the space below each question and write your answers in the spaces provided. For questions which require units, give your answers in the units stated. All diagrams are not drawn to scale.

Do not write in this space

(10 marks)

1. The square grid shows the position of points A, B, C, D, E, F, G.

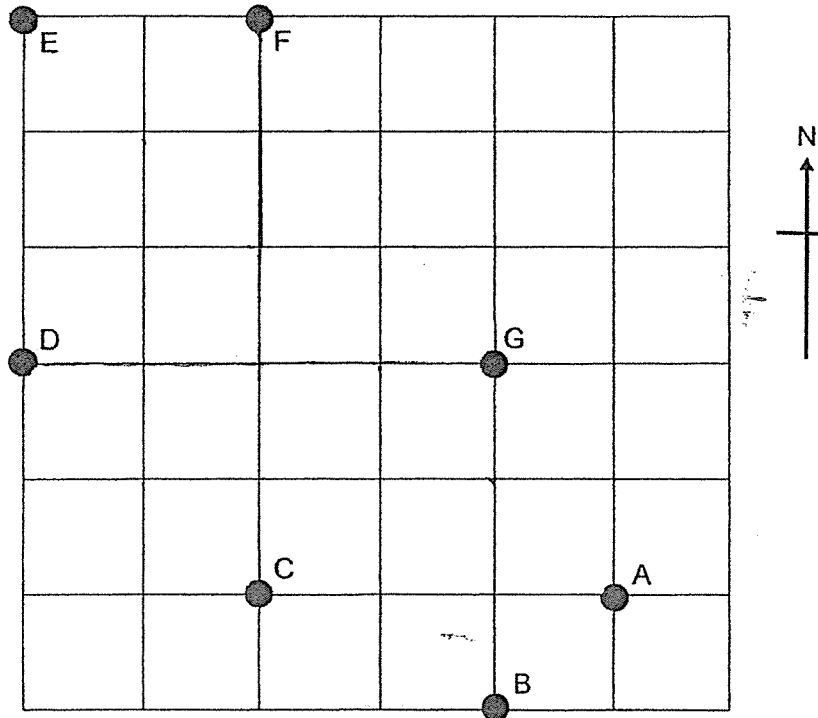

(a) Madeline walked directly from point E to point A in a straight line. In which direction did Madeline walk from point E?

Ans: (a) _____

(b) Natalie stood at one of the points facing point G. After she turned 45° clockwise, she faced point C. Which point was Natalie at before she turned?

Ans: (b) Point _____

2. 30 pupils were each assigned to fold an equal number of paper hearts for a charity drive. 3 of them were unwell and did not fold any paper hearts. The remaining pupils had to fold an additional 5 paper hearts each. How many paper hearts did each pupil had to fold at first?

Do not write
in this space

Ans: _____

3. Zach had 80 more guppies than Ken at first. Ken gave 24 of his guppies to Zach. Zach had 3 times as many guppies as Ken after that. How many guppies did Zach have at first?

Ans: _____

4. Forrest bought $3k$ boxes of chocolates. Each box contained 8 chocolates. After eating 2 boxes of chocolates, he had 200 chocolates left. What is the value of k ?

Do not write in this space

Ans: _____

5. White squares and black squares are used to form figures that follow a pattern. The first three figures are shown below.

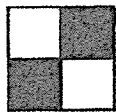

Figure 1

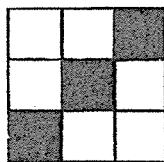

Figure 2

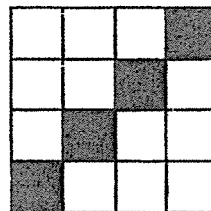

Figure 3

How many white squares are used to form Figure 30?

Ans: _____

For questions 6 to 17, show your working clearly in the space provided for each question and write your answers in the spaces provided. The number of marks available is shown in brackets [] at the end of each question or part-question. (45 marks)

Do not write
in this space

6. At first, Nathan had \$92 and Mabel had \$50. Each of them bought a book at the same price. The ratio of the amount of money Nathan and Mabel had left was 5 : 2. How much did the book cost?

Ans: _____ [3]



7. ABCD is a rhombus and DEFG is a square. Find $\angle FHD$.

Do not write
in this space

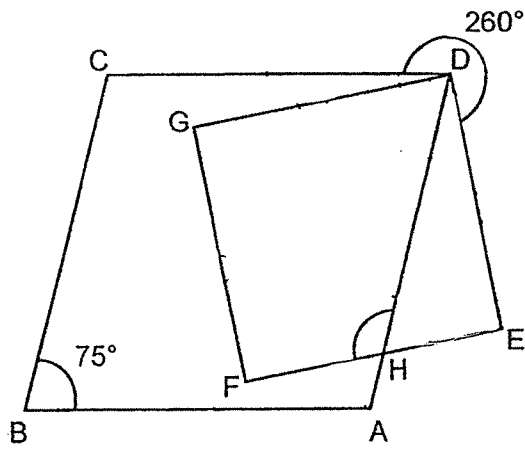

Ans: _____ [3]



8. At a walkathon, each participant from Group A and B completed either a 2-km route, 5-km route or 10-km route. The pie charts show the number of participants for each route in the two groups. Group A has twice as many participants as Group B.

Do not write
in this space

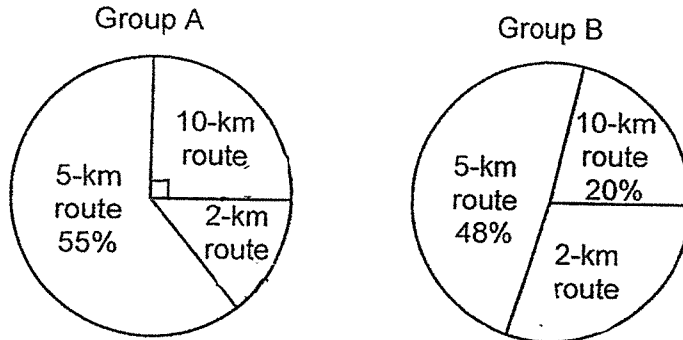

- (a) What is the ratio of the number of participants who completed the 10-km route in Group A to that of Group B? Give your answer in the simplest form.

Ans: (a) _____ [1]

- (b) The total number of participants in Group A and Group B is 150. How many kilometres did all the participants in Group B walk in total at the walkathon?

Ans: (b) _____ [2]

9. AEF and CEF are isosceles triangles with $AE = EF = CE$. Find $\angle AFB$.

Do not write
in this space

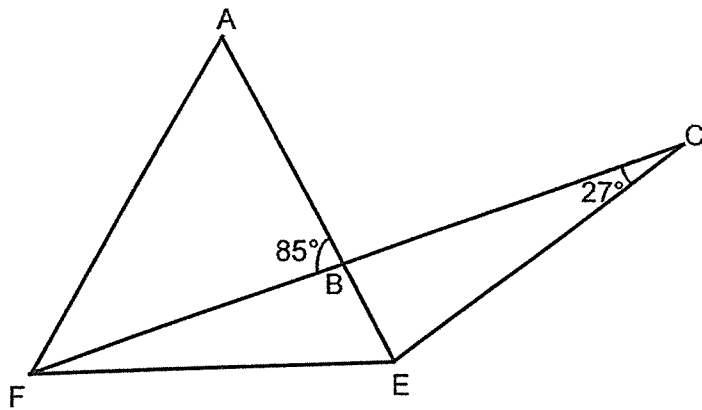

Ans: _____ [3]



10. Maverick and Nathan started jogging from the start point of a 3-km track at the same time and in the same direction. After jogging for 15 min, Nathan was 825 m ahead of Maverick. Both did not change their speeds throughout. Maverick took 24 min to reach the end point of the track. What was Nathan's jogging speed in m/min?

Do not write
in this space

Ans: _____ [3]

11. At the start of a 5-day sale, two shops A and B had 100 identical laptops each. The graphs below show the total number of laptops left unsold for each shop at the end of each day.

Do not write in this space

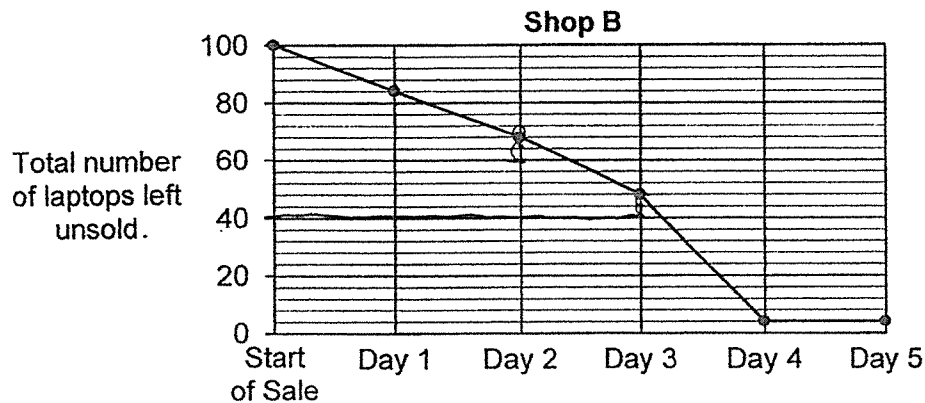
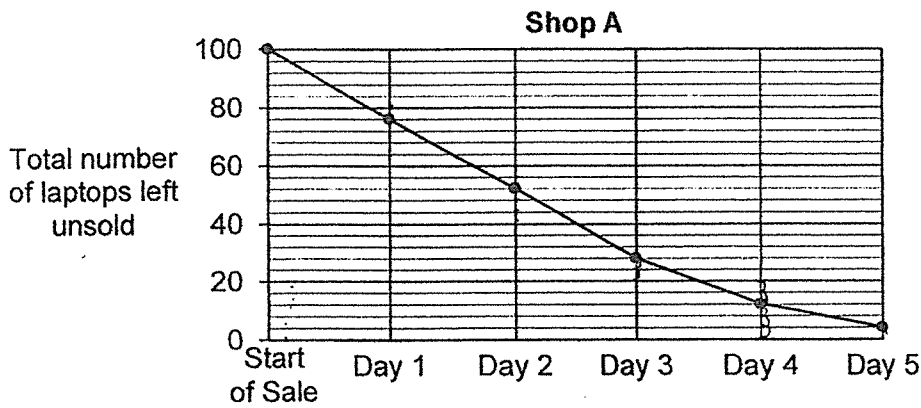

- (a) On which day did Shop A sell fewer laptops than Shop B?

Ans: (a) Day _____ [1]

- (b) After the 5-day sale, a customer paid \$4600 for all the remaining laptops in Shop A at a discount of \$50 for every \$300 spent. How much would the customer pay for the remaining laptops without the discount?

Ans: (b) _____ [3]

12. Shanti cut a square piece of paper ABCD along the dotted lines shown in Figure 1 to get one small square of area 225 cm^2 and 8 identical right-angled triangles. She removed 4 such triangles and placed them together to form a rectangle PQRS as shown in Figure 2.

Do not write
in this space

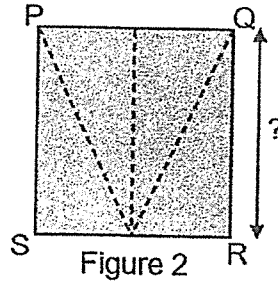
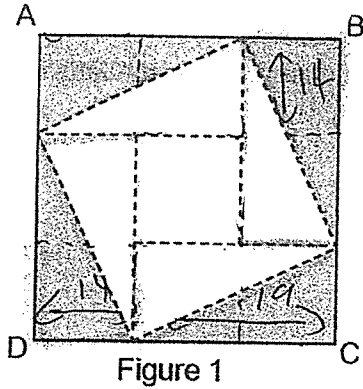

- (a) The perimeter of square ABCD is 56 cm longer than the perimeter of the rectangle PQRS. What is the length of QR?

Ans: (a) _____ [1]

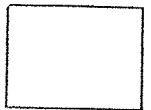

- (b) What is the area of the square paper ABCD?

Ans: (b) _____ [3]

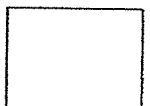

13. Abel, Ben and Chris had 448 tarts altogether. Abel gave $\frac{1}{7}$ of his tarts to Ben and $\frac{2}{5}$ of his tarts to Chris. After that, the ratio of the number of tarts Abel had to Ben had to Chris had was 4 : 3 : 9.
- (a) What fraction of his tarts did Abel have left after giving some tarts to Ben and Chris?

Do not write
in this space

Ans: (a) _____ [1]

- (b) How many more tarts did Chris have than Ben at first?

Ans: (b) _____ [3]

14. A big circle and a small circle with centre O are drawn and each circle is divided into 4 quarter circles as shown. AOB measures 28 cm. The diameter of the big circle is 8 cm longer than the small circle. (Take $\pi = 3.14$)

Do not write
in this space

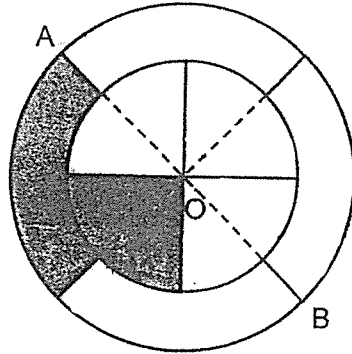

- (a) What is the area of the shaded part?

Ans: (a) _____ [2]

- (b) What is the perimeter of the shaded part?

Ans: (b) _____ [2]

15. P and Q are two rectangular containers. At first container P contained water to the height of 18.5 cm while that of container Q was 2 cm. The volume of water in container P was 1480 cm^3 .

Do not write
in this space

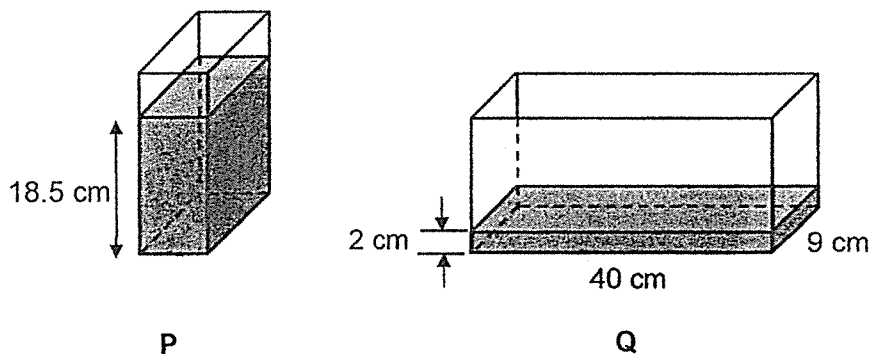

- (a) What was the base area of container P?

Ans: (a) _____ [1]

- (b) Vera poured some water from container P into container Q without spilling. After that, the height of the water level of container P was the same as that of container Q. What was the new height of the water level in container Q?

Ans: (b) _____ [3]

16. Andrew had a collection of gold, silver and bronze stars. He had 100 gold stars. 30% of his collection was silver stars. He had 12 more bronze stars than silver stars.

Do not write
in this space

(a) What was the total number of gold and bronze stars Andrew had in his collection?

Ans: (a) _____ [2]

(b) Andrew's uncle gave him some silver stars. After that, 44% of his collection was silver stars. How many silver stars did Andrew receive from his uncle?

Ans: (b) _____ [3]

17.

Figure 1 shows a plate and Figure 2 shows two stacks of identical plates. There are 3 plates in a shorter stack and 7 plates in a taller stack. The height of the shorter stack is 20 cm and the height of the taller stack is 44 cm.

Do not write in this space

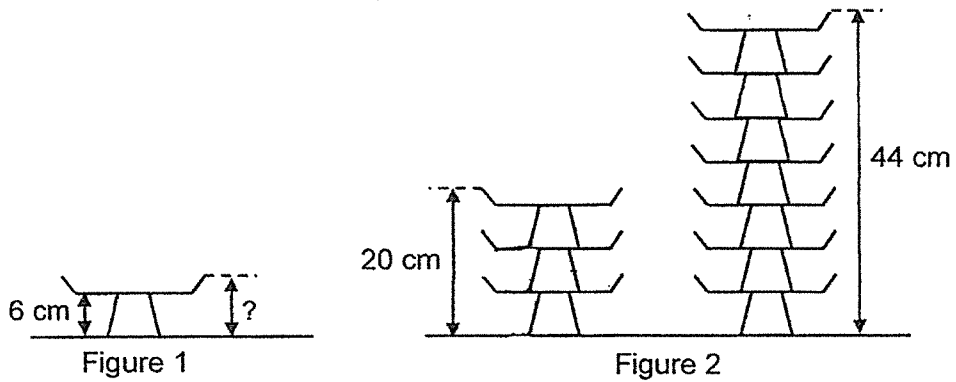

(a) Find the height of a plate.

Ans: (a) _____ [2]

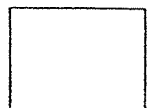

- (b) Matthew wants to pack the plates as a single stack into a box 1 m high. Figure 3 shows the 2 possible arrangement A and B. Which arrangement will allow Matthew to pack more plates? How many more?

Do not write in this space

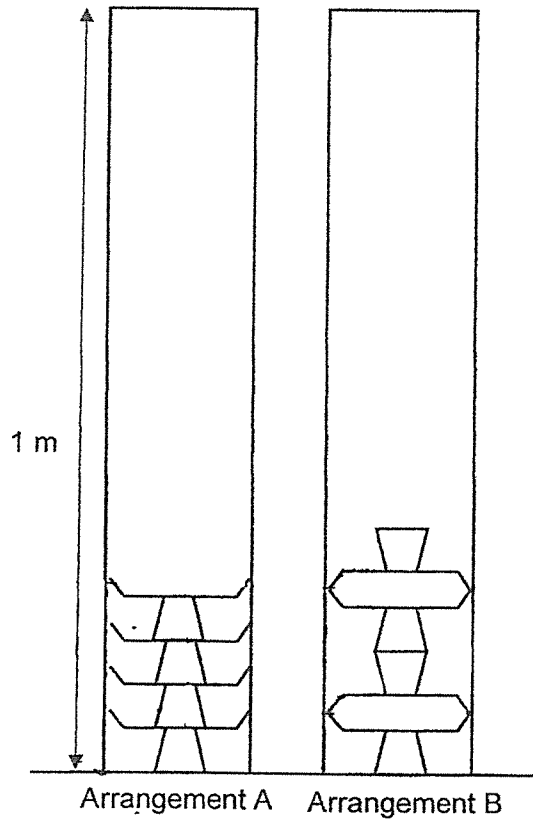

Figure 3

Ans: (b) Arrangement _____
 _____ more plates [3]



END OF PAPER 2

YEAR : 2023
 LEVEL : PRIMARY 6
 SCHOOL : CATHOLIC HIGH SCHOOL
 SUBJECT : MATHEMATICS
 TERM. : PRELIMS

Q1	Q2	Q3	Q4	Q5
3	4	2	1	2
Q6	Q7	Q8	Q9	Q10
3	4	3	1	3
Q11	Q12	Q13	Q14	Q15
1	3	2	3	3

Booklet B

16	43.6
17	$1.58 \times 10 = 15.8$ $15.8 \times 7 = 110.6$
18	$\frac{3}{5} \div 18 = \frac{1}{30}$
19	<p>A : $10.45 + 1\text{h } 35\text{min} = 12.20$</p> <p>B : $5.20 + 1\text{h } 15\text{min} = 6.35$</p> <p>$1\text{h } 35\text{min} - 0\text{h } 20\text{min} = 1\text{h } 15\text{min}$</p> <p>Ans: <u>6.35 pm</u></p>
20	
21	<p>a) 9.4 cm</p> <p>b) 125°</p>
22	<p>$(5p + 2)$</p> <p>$5p + 2 + 1p = 6p + 2$</p> <p>$6p + 5p + 2 + 2 = 11p + 4$</p> <p>Ans: $(11p + 4)$ paper cranes</p>

Q23	$145 - 70 = 75$ $75 \div 25 = 3$ $3 + 2 = 5$ hours
-----	----------------------------------------------------------

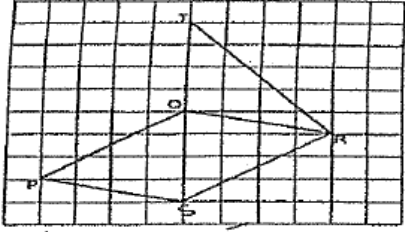
Q24	<p>(a)</p>  <p>b) $\frac{1}{2} \times 4 \times 4 = 8$ $8 \times 2 = 16$ Ans : $\frac{1}{2}$</p>
-----	-----------------------------------------------------------------------------------------------------------------------------------------------------------------------------------------------------------------------------

Q25	$6 \text{ min} = 75$ $2 \text{ min} = 25$ $20 \text{ min} = 250$
-----	------------------------------------------------------------------------

Q26	$100 - 55 = 45$ $100 + 55 = 155$
-----	-------------------------------------

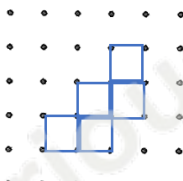
27	 <p>a) b) 7</p>
28	<p>a) Not possible to tell b) True</p>
29	$9 \times 2 = 18$ $10 \times 5 = 50$ $18 + 50 = 68$ $9 \times 7 = 63$ $5 \times 5 = 25$ $63 + 25 = 88$ Ans: 5
30	$284 \div 8 = 35 \text{ R } 4$ $34 \text{ R } 12$ $33 \text{ R } 20 (20 \div 5 = 4)$ Ans : 37 trays

Paper 2

1	<p>a) South-East b) Point D</p>
---	--------------------------------------

2	$30 - 3 = 27$ $27 \times 5 = 135$ $3u = 135$ $u = 45$ pupils
---	-----------------------------------------------------------------------

Q3	$80 + 48 = 128$ $2u = 128$ $u = 128 \div 2 = 64$ $64 + 80 = 144$ $144 + 24 = 168$
----	-----------------------------------------------------------------------------------------------

Q4	$8 \times 2 = 16$ $200 + 16 = 216$ $216 \div 8 = 27$ $3k = 27$ $1k = 27 \div 3$ $= 9$
----	------------------------------------------------------------------------------------------------------

Q5	$30 \times 31 = 930$
----	----------------------

Q6	$92 - 50 = 42$ $5 - 2 = 3$ $3u = 42$ $1u = 42 \div 3 = 14$ $2u = 14 \times 2$ $= 28$ $50 - 28 = \$22$
----	-------------------------------------------------------------------------------------------------------------------------

Q7	$360 - 260 - 75 = 25$ $180 - 90 - 25 = 65$ $180 - 65 = 115$
----	-------------------------------------------------------------------

8	<p>a)</p> $25 \times 2 = 50$ $50 : 20$ $5 : 2$ <p>b)</p> $100\% : 50$ $2\% : 1$ $48\% : 24$ $20\% : 10$ $32\% : 16$ $16 \times 2\text{km} = 32\text{km}$ $10 \times 10\text{km} = 100\text{km}$ $24 \times 5\text{km} = 120\text{km}$ $120\text{ km} + 100\text{km} + 32\text{km} = 252\text{km}$
9	$(180 - 58) \div 2 = 61$ $180 - 85 - 27 = 68$ $180 - 27 - 27 = 126$ $126 - 68 = 58$ $61 - 27 = 34$
10	$3\text{km} : 3000\text{m}$ $825 \text{ k} \div 15 = 55$ $3000\text{m} \div 24 = 125\text{m}$ $124 \text{ m} + 55 \text{ m} = 180\text{m} / \text{min}$
11	<p>a) Day 4</p> <p>b) $\\$4600 \div 250 = 18$ sets $18 \times 300 = 5400$ $5400 + 100 = \\$5500$</p>

Q12	(a) $56 \div 2 = 28$	(b) $\sqrt{225} = 15$ $28 - 15 = 13$ $13 + 28 = 41$ $41 \times 41 = 1681 \text{ } 1681 \text{ } \text{m}^2$
Q13	(a) $\frac{1}{7} = \frac{5}{35}$ $\frac{2}{5} = \frac{14}{35}$ $\frac{5}{35} + \frac{14}{35} = \frac{19}{35}$ $\frac{35}{35} - \frac{19}{35} = \frac{16}{35}$	(b) $36u - 14u = 22u$ $12u - 5u = 7u$ $22u - 7u = 15u$ $36u + 12u = 16u = 64u$ $64u = 448$ $1u = 448 \div 64 = 7$ $15u = 7 \times 15 = \underline{105}$

Q14	(a) $8 \div 2 = 4\text{cm}$ $28 - 8 = 20\text{cm}$ $20\text{cm} \div 2 = 10\text{cm}$ $10\text{cm} + 4\text{cm} = 14\text{cm}$ $\frac{1}{4} \times 3.14 \times 14\text{cm} \times 14\text{cm} = 153.86\text{cm}^2$	(b) $14 \times 2 = 28\text{cm}$ $\frac{1}{4} \times 3.14 \times 28\text{cm} = 21.98\text{cm}$ $\frac{1}{8} \times 3.14 \times 20\text{cm} = 7.85\text{cm}$ $21.98 + 7.85 + 7.85 + 8 + 20 = 65.68\text{cm}$
-----	--------------------------------------------------------------------------------------------------------------------------------------------------------------------------------------------------------------------------------	---------------------------------------------------------------------------------------------------------------------------------------------------------------------------------------------------------------------

15	(a) $1480\text{cm} \div 18.5 = 80\text{cm}^2$ (b) $H \times 80 \times H \times 40 \times 9 = 1480$ $1480 + (2 \times 40 \times 9)$ $80H \times 360H = 440$ $440H = 220 \text{ } \text{O}$) $H = 5\text{cm}$
16	a) $100\% - 60\% = 40\%$ $100 + 12 = 112$ $40\% : 112$ $1\% : 112 \div 40 = 2.8$ $30\% : 2.8 \times 30 = 84$ $84 + 12 + 100 = 196$ b) $100\% - 44\% = 56\%$ $56\% : 196$ $44\% : 154$ $154 - 84 = 70$
17	(a) $6 \times 3 = 18$ $20 - 18 = 2$ $6 + 2 = 8$ b) $100 - 8 = 92$ $92 \div 6 = 15$ $100 \div 8 = 12.5 \approx 12$ A: $15 + 1 = 16$ B: $100 \div 8 = 12$ $16 - 12 = 4$ Ans: Arrangement A, 4 more plants