



Anglo-Chinese School (Junior)

PRELIMINARY EXAMINATION (2022)

PRIMARY 6

SCIENCE

BOOKLET A

Tuesday

23 August 2022

1 h 45 min

Name: \_\_\_\_\_ ( ) Class: 6.( )

**INSTRUCTIONS TO PUPILS**

- 1 Do not turn over the pages until you are told to do so.
- 2 Follow all instructions carefully.
- 3 There are 28 questions in this booklet.
- 4 Answer ALL questions.
- 5 Shade your answers in the Optical Answer Sheet (OAS) provided.

---

This question paper consists of 23 printed pages (inclusive of cover page).

For each question from 1 to 28, four options are given. One of them is the correct answer. Make your choice (1, 2, 3 or 4). Shade your answer on the Optical Answer Sheet (56 marks)

1. Jeralyn made four statements about organism K as shown.

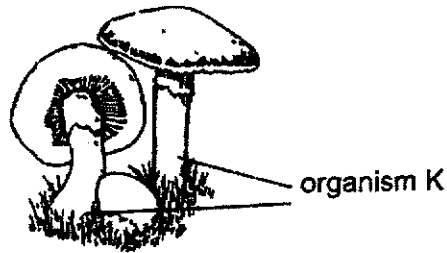

Which of the following statements allowed Jeralyn to conclude that organism K is not a plant?

- (1) It grows on land.
  - (2) It reproduces by spores.
  - (3) It feeds on living things dead or alive.
  - (4) It needs air, food and water to survive.
2. Organs A, B, C and D are part of the human digestive system. The table shows the function(s) of organs A, B, C and D.

Function	Organ(s)
Digestion of food	A, B, D
Absorption of digested food	A
Absorption of water	C

What are organs, A, B, C and D?

	A	B	C	D
(1)	Stomach	Mouth	Large intestine	Small intestine
(2)	Stomach	Large intestine	Small intestine	Mouth
(3)	Small intestine	Stomach	Large intestine	Mouth
(4)	Small intestine	Mouth	Stomach	Large intestine

3. Alex prepared two similar set-ups, A and B and placed them next to a window. He wrapped the roots of set-up B in a plastic bag. After a few days, he observed that the leaves of the plant in set-up B wilted.

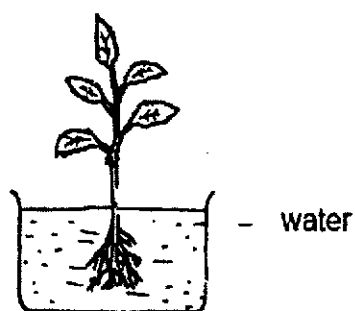

Set-up A

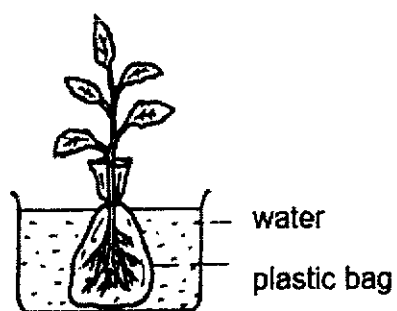

Set-up B

What does his experiment show?

- A Roots take in water.
- B Plants need water to survive.
- C The plants did not receive enough sunlight.
- D The plastic bag allows water to enter the roots.

- (1) A and B only
- (2) B and C only
- (3) A and D only
- (4) A, C and D only

4. Jansen set up an experiment as shown.

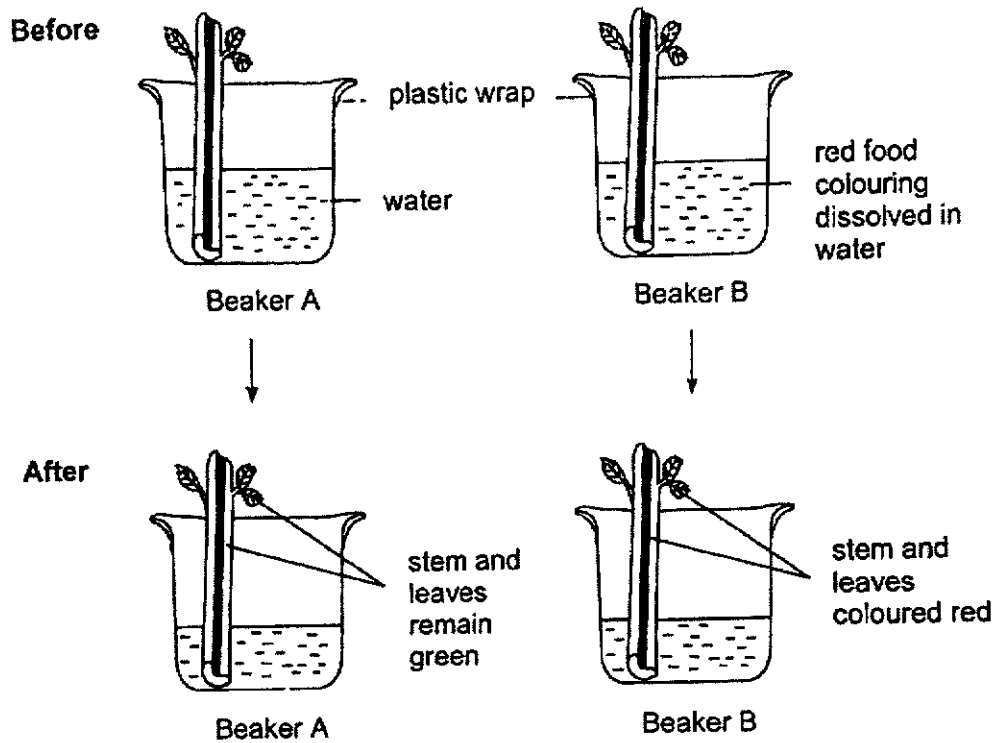

Which of the following observation and conclusion are correct?

	Observation	Conclusion
(1)	The water level in both beakers decreased.	The celery leaves absorb the coloured water.
(2)	The celery stem and leaves in Beaker B were coloured red.	The tubes in the celery stem transport coloured water.
(3)	Only the water level in Beaker A decreased.	The celery stem only transport water that is not coloured.
(4)	There is no change in the water level in both beakers after the experiment.	Without roots, the celery stem cannot take in water.

5. The diagram shows how blood is transported through different blood vessels in the human body.

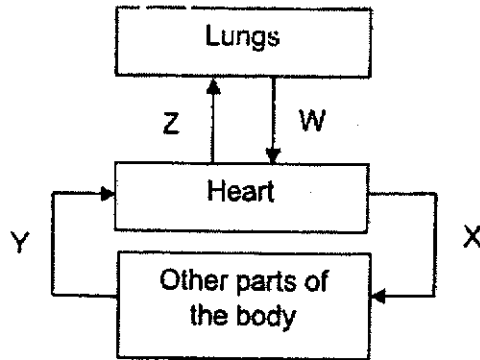

Four different blood samples, A, B, C and D, were taken from the four different blood vessels, W, X, Y and Z. The graph shows the amount of oxygen in the blood sample from each blood vessel.

amount of oxygen  
in blood ( $\text{cm}^3$ )

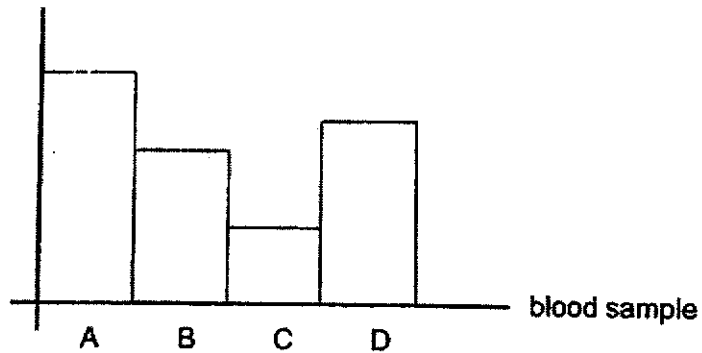

Which blood sample is from the blood vessel that was carrying blood from the heart to the other parts of the body?

- (1) A
- (2) B
- (3) C
- (4) D

6. Study the flowchart.

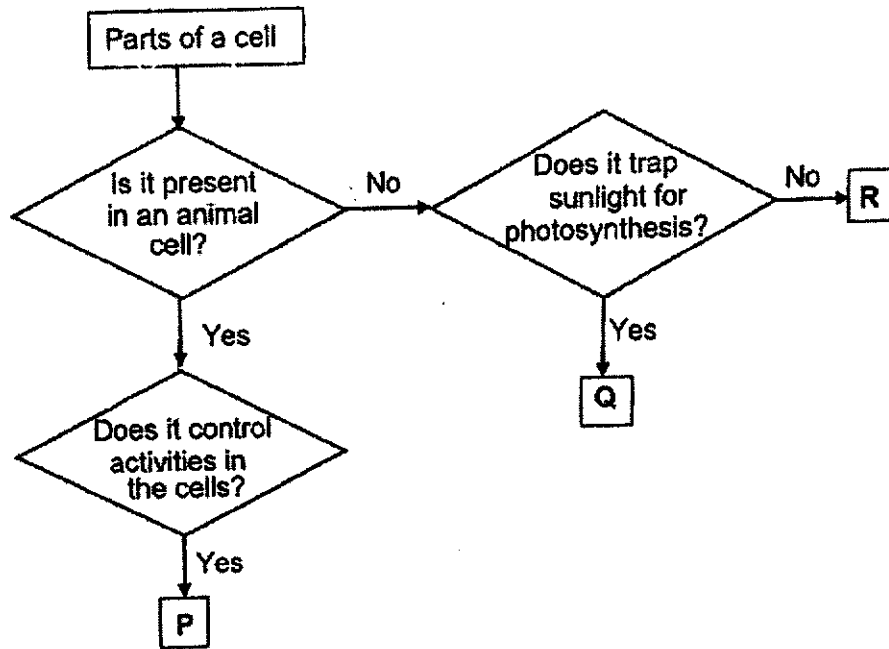

Which one of the following represents P, Q and R respectively?

	P	Q	R
(1)	nucleus	cytoplasm	chloroplasts
(2)	nucleus	chloroplasts	cell wall
(3)	cell membrane	chloroplasts	cytoplasm
(4)	nucleus	chloroplasts	cell membrane

7. What is a community?

- (1) Organisms adapting to the place that they live in.
- (2) The same type of organism living together within a particular area.
- (3) Different types of organisms living together in a habitat interacting with one another.
- (4) Different types of organisms interacting with other living and non-living things in an area.

8. Oliver spotted the egg of an insect on a plant in his garden. He recorded the mass of leaves on the plant as the egg developed through its life cycle and plotted the graph.

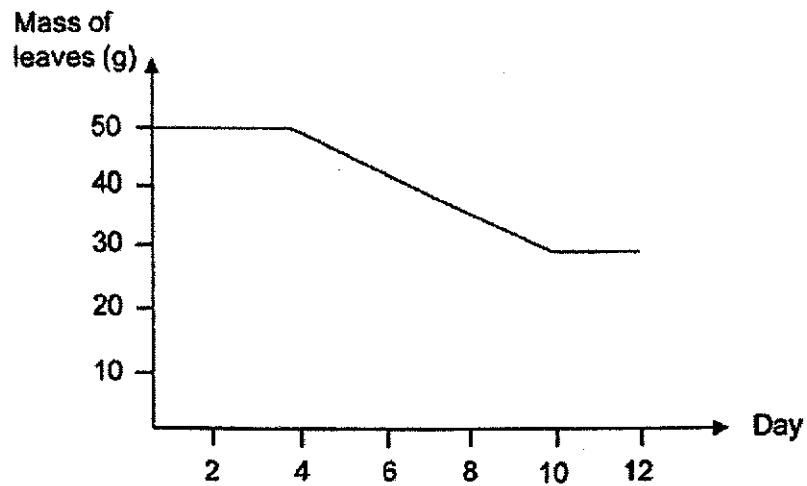

Which of the following about the development of the egg is likely to be correct?

	Developed into larva	Developed into pupa
(1)	Day 1	Day 10
(2)	Day 1	Day 12
(3)	Day 4	Day 10
(4)	Day 4	Day 12

9. Which of the following carry genetic information?

- (1) The sperm and the egg
- (2) The penis and the vagina
- (3) The testes and the ovaries
- (4) The womb and the ovaries

10. Which of the following statements describe the behavioural adaptation of an earthworm?

- (1) It burrows into the soil to hide from predators.
- (2) It has strong muscles to help it to burrow into the soil.
- (3) It has hair on its body to provide grip to move through the soil.
- (4) It has a streamlined body shape to burrow through the soil faster.

11. P, Q, R and S are four populations living in a community.

The following relationships exist amongst them.

- P has two predators.
- Q and R have two sources of food.
- Q is the only animal and plant eater.
- S is the only producer.

Which of the following food web shows the food relationship in the community?

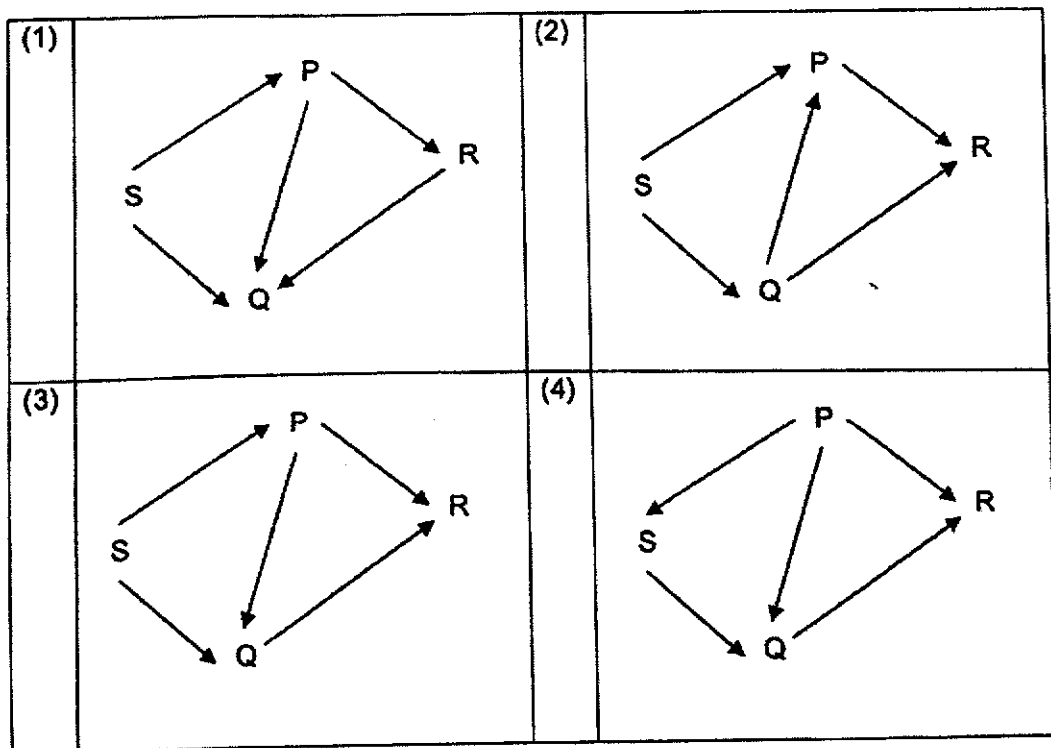



12. Ethan wrapped a seed in some wet cotton wool and another seed in some dry cotton wool and placed them inside a wooden cupboard. After three days, he discovered that the seed with the wet cotton wool had germinated. What is the aim of his experiment?
- (1) To find out if seeds need air to germinate.
  - (2) To find out if seeds need water to germinate.
  - (3) To find out if seeds need soil and light to germinate.
  - (4) To find out if seeds need air and water to germinate.
13. Freshwater fishes often migrate between habitats for breeding and feeding. Some examples include salmon and freshwater eel. Over the years, the population of freshwater fishes has decreased drastically as shown in the graph.

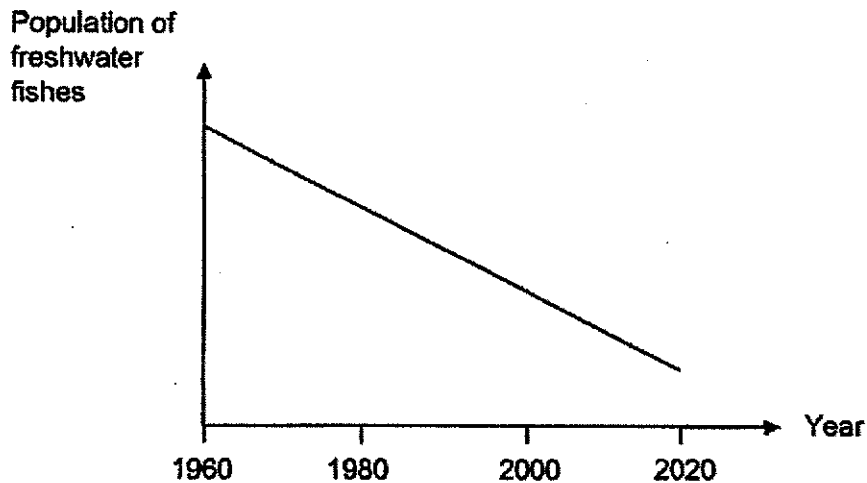

Which of the following are likely cause(s) of the decline in the population of freshwater fishes?

- A Overfishing
  - B Water pollution
  - C Building of hydropower dams
  - D Building of freshwater fish farms
- (1) B and C only
  - (2) C and D only
  - (3) A, B and C only
  - (4) A, B and D only

14. Evan set up an experiment with substance Z in an open field as shown.

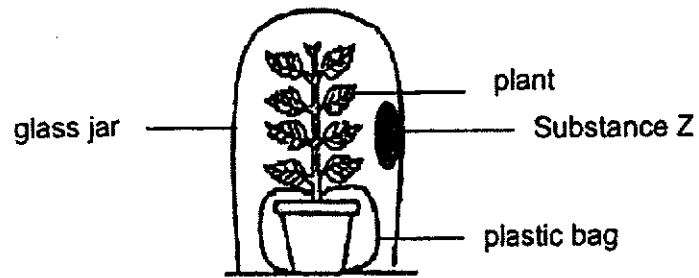

Substance Z changes colour according to the amount of oxygen present in the jar as shown in the table.

Amount of Oxygen	Colour of Z
Decreases	Green
Normal	Red
Increases	Yellow

What is the likely colour of Substance Z at 1a.m. and 1p.m. respectively?

	Colour of Z at 1a.m.	Colour of Z at 1p.m.
(1)	Green	Red
(2)	Red	Red
(3)	Green	Yellow
(4)	Yellow	Green

15. Questions 15 and 16 are based on the set-up shown.  
Christian set up an experiment using a magnet, a spring and a ball.

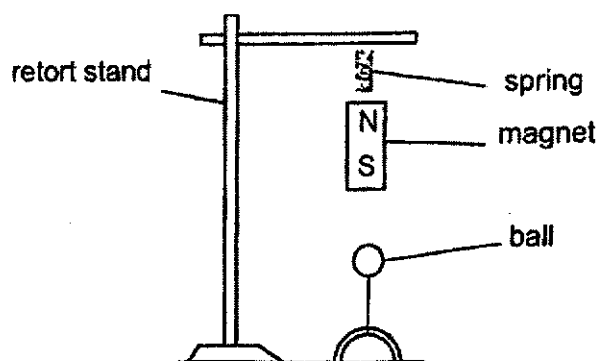

- Which of the following material is **not** a choice for the ball?
- (1) Iron
  - (2) Steel
  - (3) Lodestone
  - (4) Aluminium
16. Which of the following about Christian's experiment are correct?
- A Gravitational force is pulling the ball down.
  - B Elastic spring force is acting on the magnet.
  - C Magnetic force is making the ball float in the air.
- (1) A and B only
  - (2) A and C only
  - (3) B and C only
  - (4) A, B and C

17. Elijah recorded the volume of four objects A, B, C and D.

Object	Volume of object (cm <sup>3</sup> )
A	600
B	900
C	500
D	700

Elijah studied the water tank used to flush the toilet bowl in his house. After flushing, water enters and re-fills the tank. The tank will stop filling up when the water reaches level L.

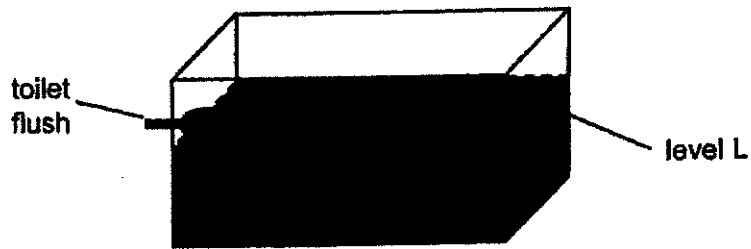

Which object A, B, C or D, when fully submerged, should Elijah put inside the water tank so that he uses the least amount of water to flush the toilet bowl to save water?

- (1) A
- (2) B
- (3) C
- (4) D

18. The diagram shows four circuits with identical batteries and bulbs in working condition.

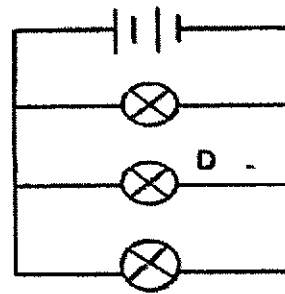
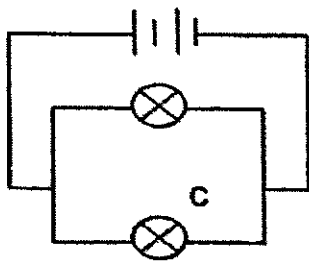
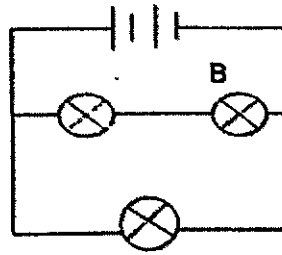
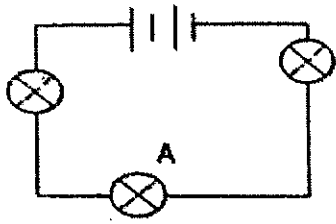

Which bulb will be the least bright?

- (1) A
- (2) B
- (3) C
- (4) D

19. The diagram shows a music box.

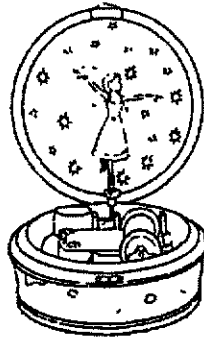

The table shows the observations when switches, S1 and/or S2, is open or closed.

S1	S2	Observation
Closed	Open	Light only
Open	Closed	Music only
Open	Open	No music and light

Which of the following represents the circuit in the music box?

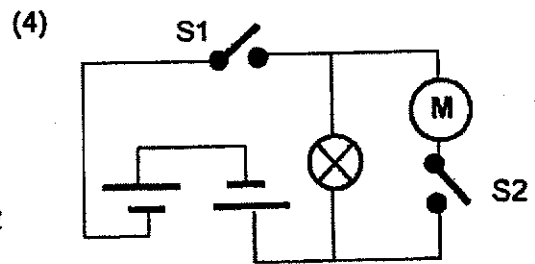
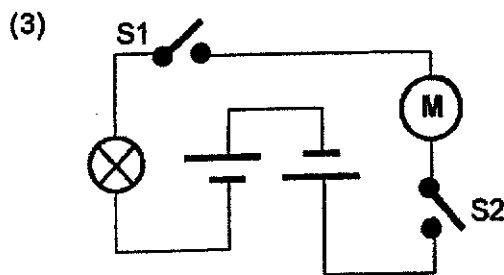
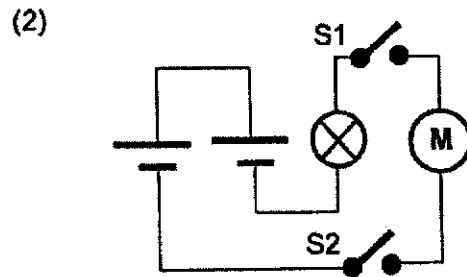
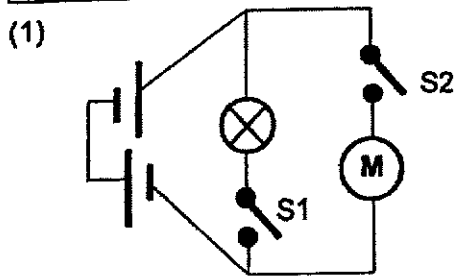
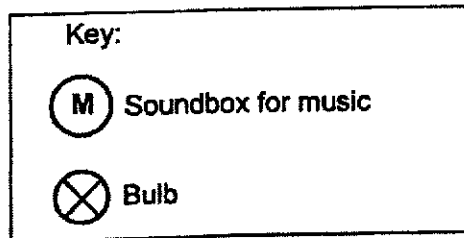

20. The diagram shows three objects, A, B and C, of the same shape but of different sizes and made from different materials.



Object A  
(Opaque)

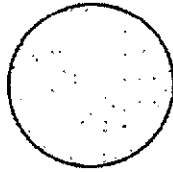

Object B  
(Translucent)

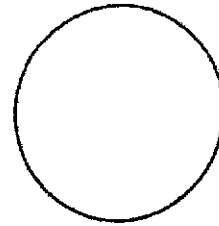

Object C  
(Transparent)

The objects are then suspended by strings and placed between a torch and a white screen as shown.

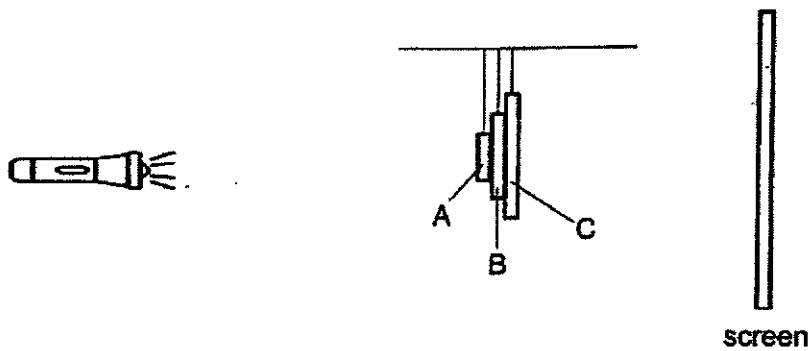

Which of the following shows the shadow formed by objects A, B and C on the screen?

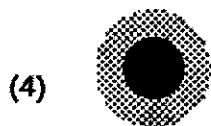
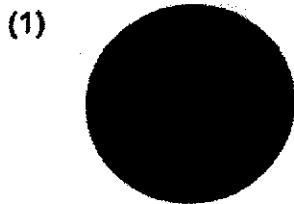

21. Sam put 200ml of water at 10°C into a styrofoam cup and a plastic cup of the same size and temperature.

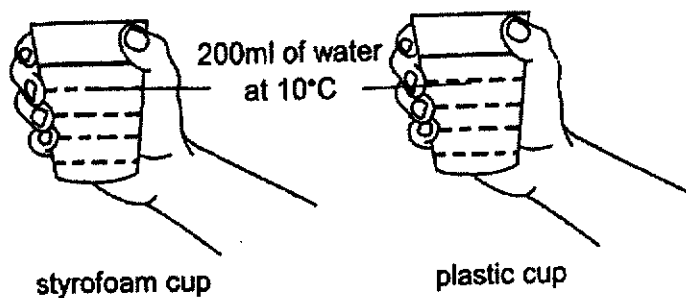

After five minutes, he held both cups at the same time. The hand with the plastic cup felt colder.

Why did the plastic cup feel colder than the styrofoam cup to Sam?

- (1) The plastic cup is a poorer conductor of heat than the styrofoam cup.
- (2) The plastic cup gained heat faster from his hand than the styrofoam cup.
- (3) The plastic cup lost heat faster to the surrounding air than the styrofoam cup.
- (4) The temperature of the water in the plastic cup was warmer than that in the styrofoam cup.



22. Nisa wanted to find out if heat travelled through some metals faster than others. She used three different types of metal strips, A, B and C, of the same size. The stands and candles used are identical.

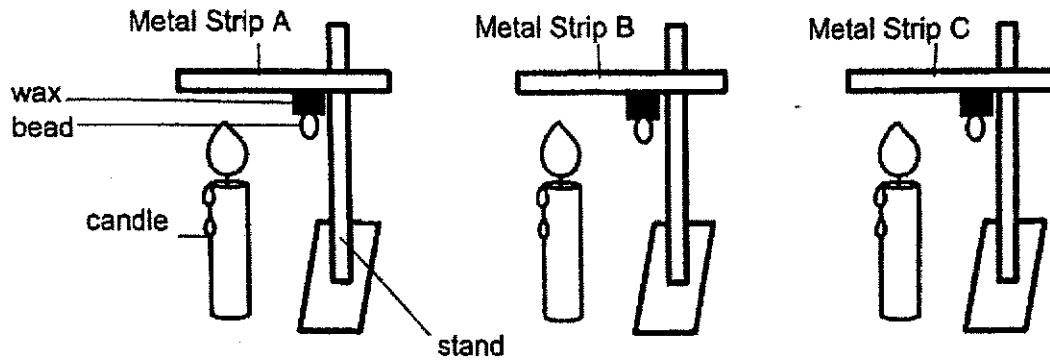

Wax was used to attach identical beads to the metal strips. The beads fell off when the wax melted.

What other variable did Nisa have to keep the same in the experiment to ensure a fair test?

- (1) Colour of bead
- (2) Time it takes for each bead to fall
- (3) Final temperature of each metal strip
- (4) Distance between the bead and the candle

23. Study the diagram.

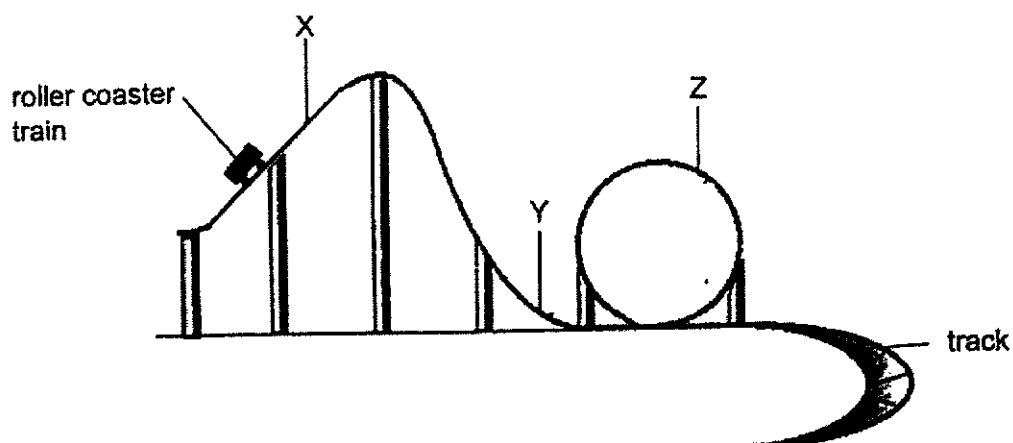

Which of the following statements is/are true about the energy possessed by the roller coaster train at various positions, X, Y and/or Z of the track?

- A The train has potential energy at position X.
- B The train has more kinetic energy at position Z than at position Y.
- C The train has more kinetic energy than potential energy at position Y.

- (1) A only
- (2) A and C only
- (3) B and C only
- (4) A, B and C

24. Study the diagrams.



Climbing



Swimming

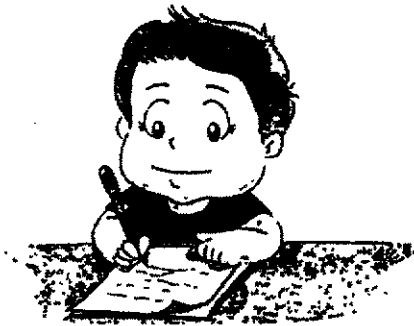

Writing



Walking

During which activities is friction useful?

- (1) Climbing and walking
- (2) Swimming and writing
- (3) Climbing, writing and walking
- (4) Swimming, writing and walking

25. Jacob conducted an experiment with two springs, A and B, which are 4 cm long. He hung weights of the same mass, one at a time on each spring, and recorded the extension of the springs in the graph.

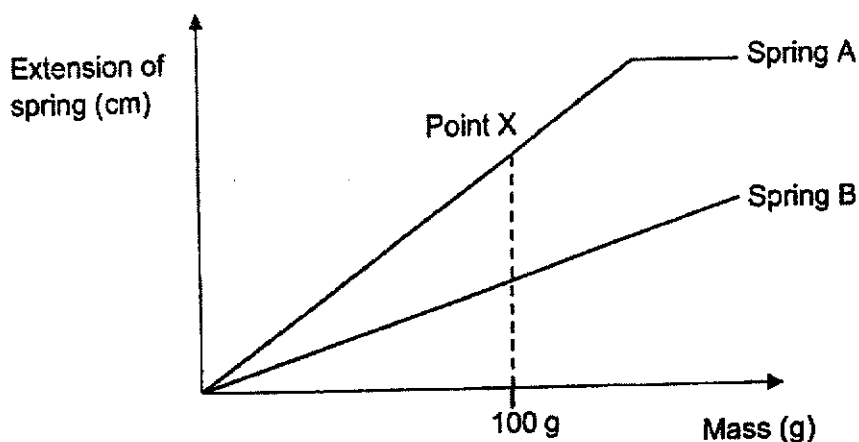

Which of the following is correct?

	Statement	True	False	Not possible to tell
(1)	When the same mass is added to both springs, Spring B extends more than Spring A.	✓		
(2)	At Point X, when the masses are removed, Spring A returns to its original length faster than Spring B.			✓
(3)	When more mass is added to the springs, Spring B will be the first spring to not be able to extend further.	✓		
(4)	The original length of Spring A is the same as Spring B.		✓	

26. Questions 26 and 27 are based on the set-up shown.

Brayen prepared set-up A based on the water cycle. He poured some seawater with yellow food dye into a glass tank and left the tank in an open field on a sunny day for six hours.

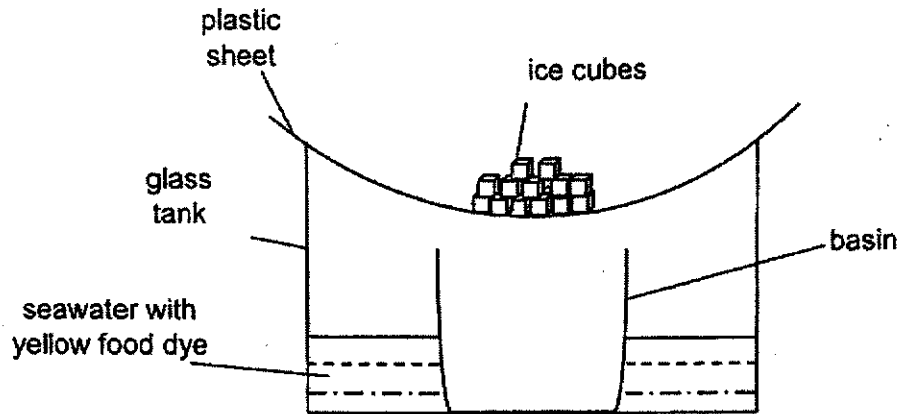

Set-up A

Which of the following describes the liquid collected in the basin and its explanation?

	Description of liquid collected in the basin	Explanation
(1)	Yellow salty liquid.	The seawater with yellow food dye evaporated.
(2)	Yellow salty liquid.	The ice cubes melted and mixed with the seawater with yellow food dye.
(3)	Clear, tasteless liquid.	Water in the seawater with yellow food dye evaporated.
(4)	Clear, tasteless liquid.	Water from the ice cubes evaporated.

27. Brayon decided to change the basin to a wider one to collect liquid in six hours as shown in set-up B.

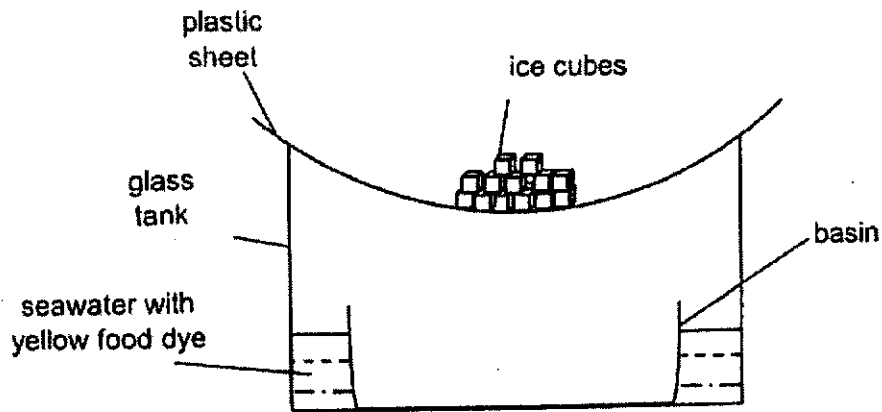

Set-up B

Which of the following correctly shows the volume of liquid collected as compared to Set-up A and its explanation?

	Volume of liquid collected in Set-up B as compared to Set-up A	Explanation
(1)	More	A bigger basin can collect more water.
(2)	More	Rate of evaporation and condensation is faster.
(3)	Less	Rate of evaporation and condensation is slower.
(4)	The same	The size of the basin has no effect on the amount of water collected.

28. Matt placed a solid made of Substances K and L in the set-up shown. Substance K has a lower melting point than Substance L.

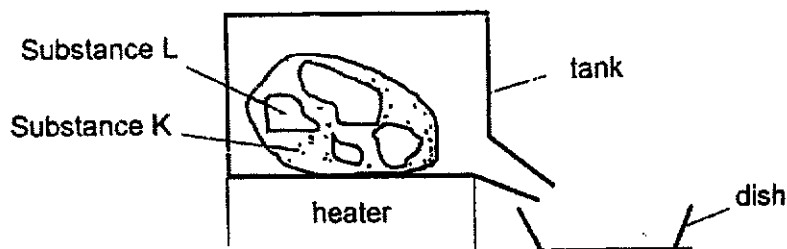

Matt wanted to obtain a solid made of Substance K only.

In order to ensure that the solid does not contain Substance L, which of the following is the most suitable temperature for the heater?

- (1) Below Substance L's melting point.
- (2) Above Substance K's melting point.
- (3) At the melting point of Substance L.
- (4) Above Substance K's melting point but below Substance L's melting point.

**End of Booklet A**



--	--	--	--	--	--	--	--	--	--

Anglo-Chinese School (Junior)

PRELIMINARY EXAMINATION (2022)

PRIMARY 6

SCIENCE

BOOKLET B

Tuesday

23 August 2022

1 h 45 min

Name: \_\_\_\_\_ ( ) Class: 6.( ) Parent's Signature: \_\_\_\_\_

**INSTRUCTIONS TO PUPILS**

- 1 Do not turn over the pages until you are told to do so.
- 2 Follow all instructions carefully.
- 3 Answer ALL questions.
- 4 Use a dark blue or black ballpoint pen to write your answers in the space provided for each question.
- 5 Do not use correction fluid/tape or highlighters.
- 6 The marks are given in the brackets [ ] at the end of each question or part question.

Booklet	Possible Marks	Marks Obtained
A	56	
B	44	
Total	100	

---

This question paper consists of 19 printed pages (inclusive of cover page).



**Booklet B (44 marks)**

For questions 29 to 40, write your answers in this booklet.

The number of marks available is shown in brackets [ ] at the end of each question or part question.

29. Jean poured 200ml of digestive juice into two similar containers, P and Q. She added 10g of food sample X into each container. The food in container P was cut into small pieces as shown in the diagram.

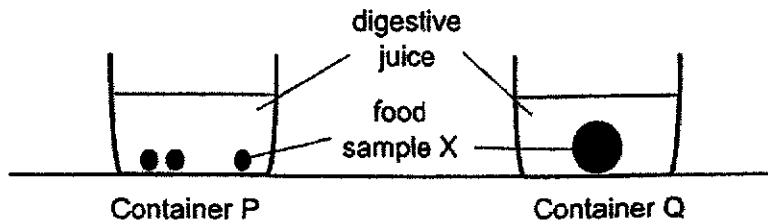

After two hours, Jean measured and recorded the mass of food sample X left in each container in the table.

Container	Mass of food left in the container (g)
P	4
Q	7

Please do not write in the margin.

Please do not write in the margin.

- (a) What is the changed variable of Jean's experiment? [1]

---



---

- (b) What should Jean do to obtain more reliable results? [1]

---



---

Jean prepared Container R with 200ml of digestive juice and 10g of food sample X cut into smaller pieces than those in Container P.

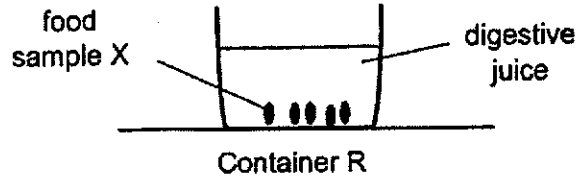

Please do not write in the margin.

(c) Predict the mass of food sample X left after two hours.

[1]

---

(d) Based on the results of the experiment, explain how chewing helps with digestion.

[1]

---



---

Please do not write in the margin

SCORE	2
-------	---

30. Devan carried out an experiment to measure the volume of blood supplied per minute to different parts of the human body during resting and playing tennis.

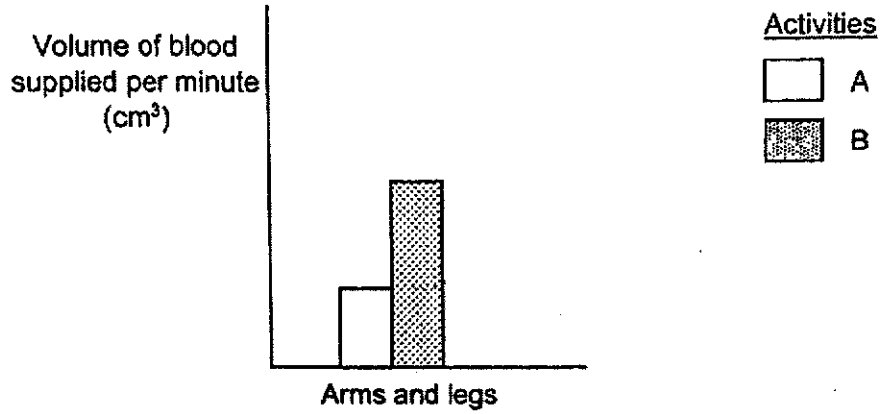

Please do not write in the margin.

(a) Which activity, resting or playing tennis, was A?

[1]

---

(b) Describe how oxygen in the environment reaches Devan's arms and legs.

[2]

---

---

---

---

Please do not write in the margin.

SCORE	3
-------	---

31. Asher conducted an experiment to find out how the sharpness of a pencil affects the depth it pierces into a block of plasticine. He used two identical pencils with tips of different sharpness and dropped them from the same height of 1 metre.

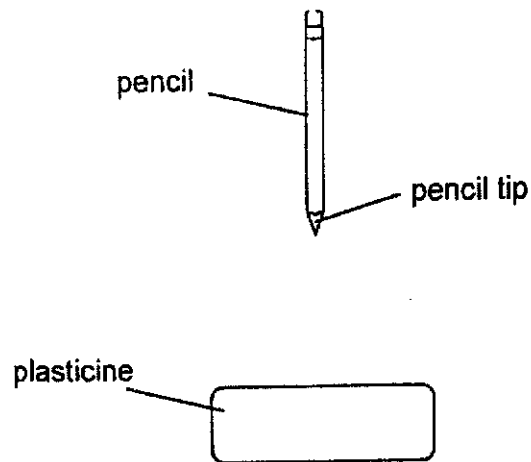

He recorded his observations in the table.

Type of pencil tip	Depth of piercing (cm)	Does the pencil stay in the plasticine?
Blunt pencil tip	1	No
Sharp pencil tip	2	Yes

- (a) What can Asher conclude about the depth of piercing by the type of pencil tip from his experiment? [1]

---



---

Please do not write in the margin.

Please do not write in the margin.

Mangrove forests can be found in coastal areas in Singapore and Malaysia. The coastal areas where the trees grow can be muddy or even flooded, depending on the tide.

The seeds of a mangrove tree germinate into seedlings while on the tree. Once the seedlings can make their own food, they drop into the soil below the parent plant.

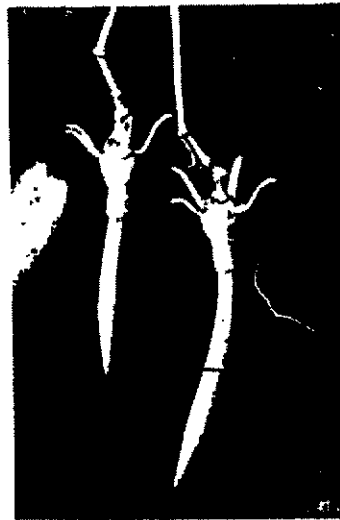

seedling

sharp tip  
at the end  
of the  
roots

Please do not write in the margin.

- (b) Based on the experiment, explain how the sharp tip at the end of the seedling's roots help the seedling grow into a tree in the muddy soil. [1]

---



---

- (c) State a disadvantage of the seedlings dropping into the muddy soil below the parent plant and growing there. [1]

---



---

Please do not write in the margin.

32. Emmanuel conducted an experiment using four identical containers.

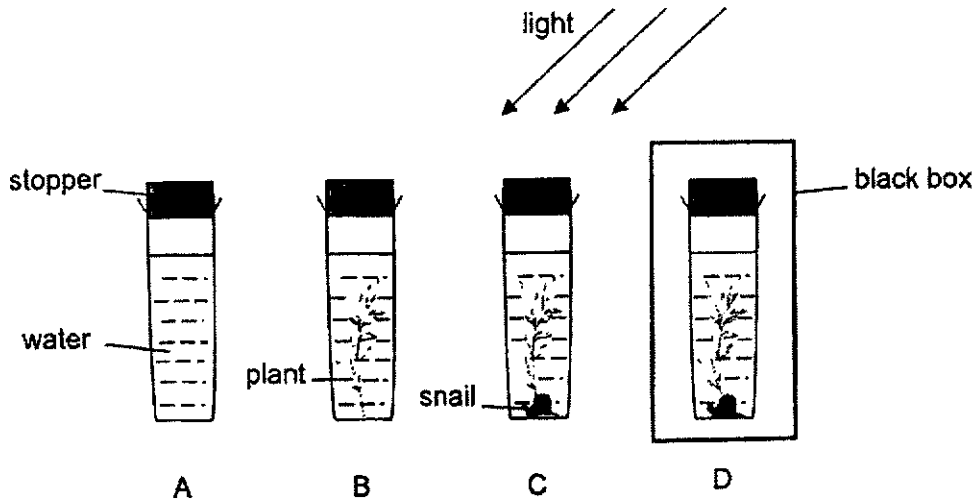

After three hours, a drop of blue Liquid Z was added to each container. The colour of the liquid in the container changes shade according to the amount of oxygen present in the liquid.

(a) Each number represents a different shade of blue. The number for the shade of the liquid in container A is 4.

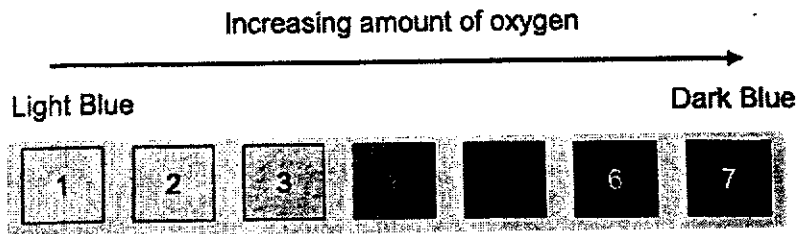

Suggest a number for the shade of the liquid in containers B and D. [1]

Container B: \_\_\_\_\_ Container D: \_\_\_\_\_

(b) Emmanuel predicted that container C has more carbon dioxide than container A. Explain why container C may not have more carbon dioxide than container A. [2]

---



---



---

Please do not write in the margin.

Please do not write in the margin.

33. Elliott placed a strip of material A and material B of the same size across two tables as shown.

He tested the materials in the Science Lab by adding masses to them. He measured and recorded the distance,  $d$ , from the floor to the bottom of each material for different masses.

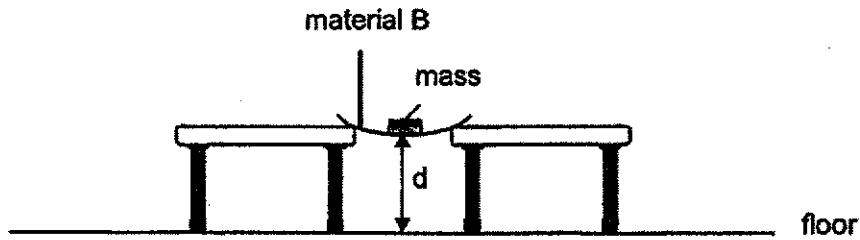
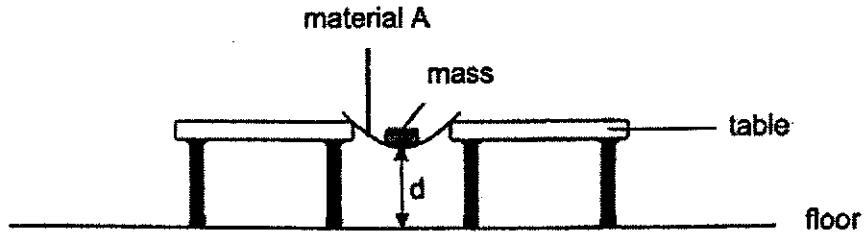

Please do not write in the margin.

Please do not write in the margin.

(a) State two other variables that Elliott must keep the same for a fair test.

[1]

---

---

---

SCORE	1
-------	---

Elliott recorded his results in the table as shown.

Mass added to material (g)	Distance d (cm)	
	Material A	Material B
0	8	8
50	7	8
100	6	7
150	5	7
200	4	6
250	3	6

Please do not write in the margin.

(b) Name the property of the materials that Elliott is testing.

[1]

---

(c) The picture shows a weaving basket.

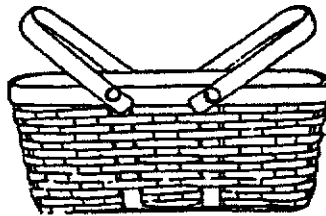

Part X

Which material, A or B, is more suitable to make Part X of a weaving basket?  
Explain your answer based on the results.

[1]

---



---

Please do not write in the margin.



34. (a) State the difference between evaporation and boiling of a liquid. [1]

---



---

Russell sets up an experiment in an open field on a windy day as shown.

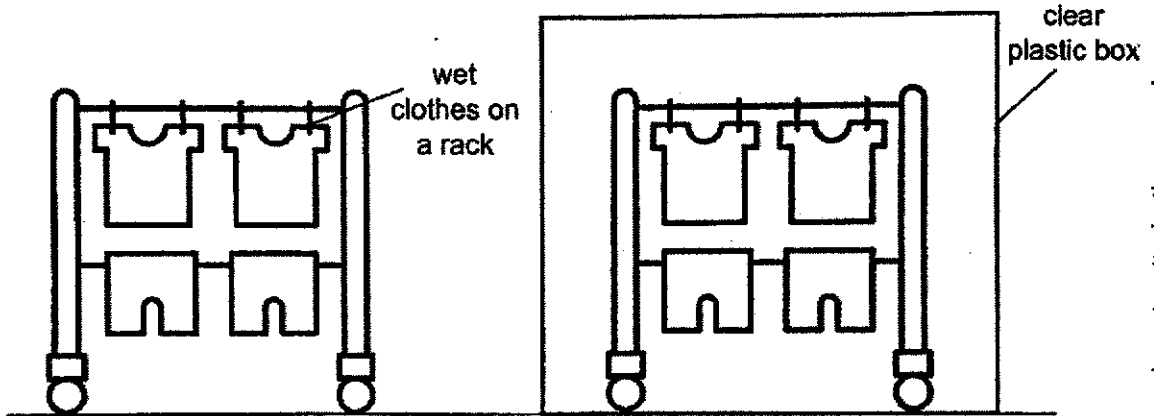

Please do not write in the margin.

Please do not write in the margin.

(b) State a possible hypothesis on whether wind affects how fast the wet clothes dry. [1]

---



---

- (c) After five hours, Russell realised that water droplets had formed on the inside of the clear plastic box. Explain how this could have happened. [2]

---

---

---

---

---

Please do not write in the margin.

Please do not write in the margin.

35. Brandon placed 1000 cm<sup>3</sup> of water at 10°C into a container. He measured the changes in the volume of the contents in the container from 10°C to 0°C and recorded his findings in the table.

Temperature (°C)	Volume of contents (cm <sup>3</sup> )
10	1000
8	999
6	998
4	997
2	998
0	1090

(a) State the relationship between temperature and the volume of the contents. [2]

Please do not write in the margin.

---



---



---

Please do not write in the margin.

Brandon filled a glass bottle to the brim with water at 10°C and closed the lid tightly. He then put the bottle in the freezer, which is at 0°C.

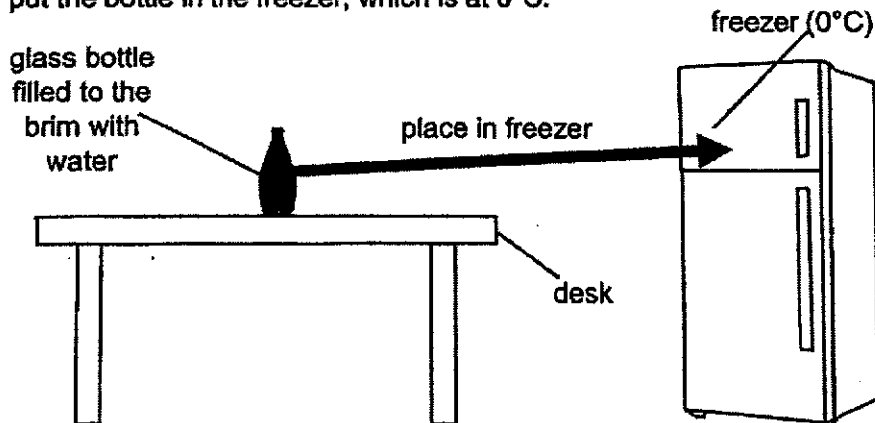

(b) The next day, Brandon wanted to take the glass bottle out, but he discovered that it had broken into pieces. Based on the information in the table, explain why this happened. [2]

---



---

36. Mingzhe sets up two electrical circuits, K and L, with identical bulbs and one battery. The battery and bulbs are in working condition.

He measures and records the amount of light from the same bulb in each circuit as he adds more bulbs to the circuits in the graph.

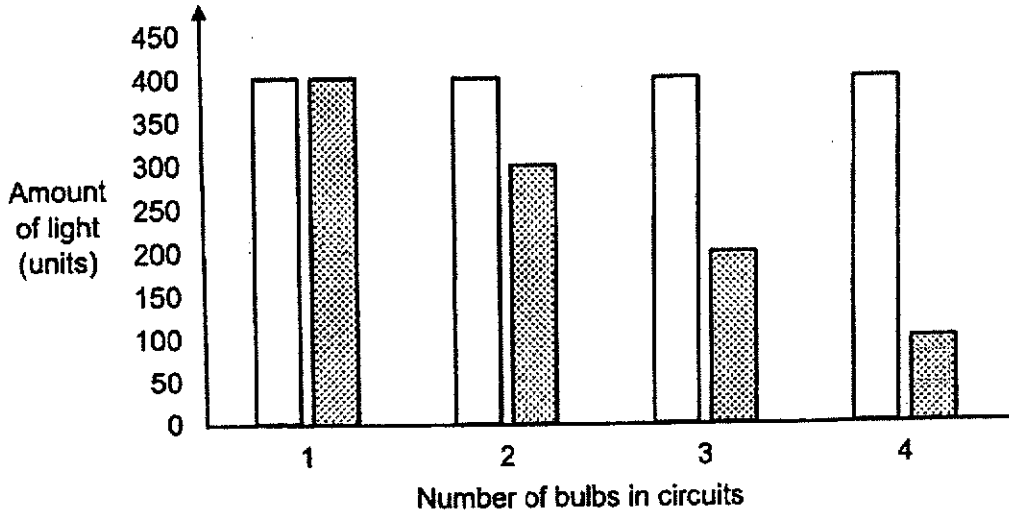

Key:



Circuit K



Circuit L

Please do not write in the margin.

Please do not write in the margin.

(a) How are the bulbs arranged in Circuit L? Explain your answer. [1]

---



---

(b) State an advantage Circuit K has over Circuit L. [1]

---



---

Mingzhe sets up Circuit T as shown in the diagram.

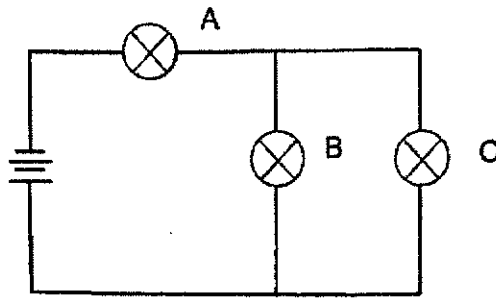

Circuit T

Please do not write in the margin.

- (c) Mingzhe wants to add a switch in Circuit T which will allow him to only control bulb B. Mark an 'X' in Circuit T to show where he should add the switch. [1]
- (d) Suggest how Mingzhe could make the bulbs in Circuit T brighter without removing or rearranging any bulbs. [1]

---



---

Please do not write in the margin.

SCORE	2
-------	---

37. The diagram shows Adriel jumping on a trampoline. As he continues bouncing, he jumps higher and higher. As he lands onto the trampoline mat, the mat dips lower each time and the springs attached to the mat extends further.

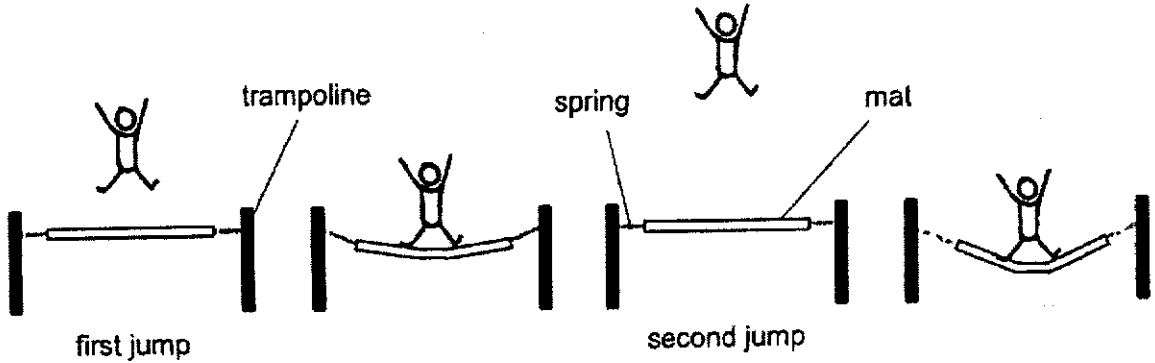

Please do not write in the margin.

Please do not write in the margin.

(a) Based on the diagrams, explain in terms of forces, why Adriel's second jump on the trampoline is higher than the first jump. [2]

---



---



---

(b) The bar graph shows the amount of gravitational force acting on Adriel for his first jump. Draw the bar for his second jump. [1]

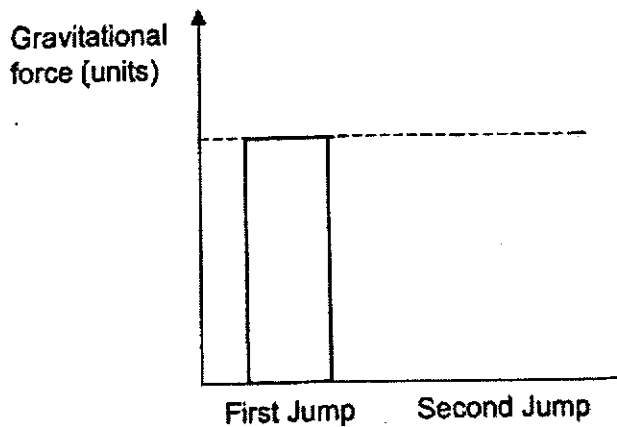

SCORE	3
-------	---

38. The diagram shows the stroke method to make a temporary magnet. As the steel bar is stroked, end A of the steel bar becomes the North pole and end B becomes the South pole.

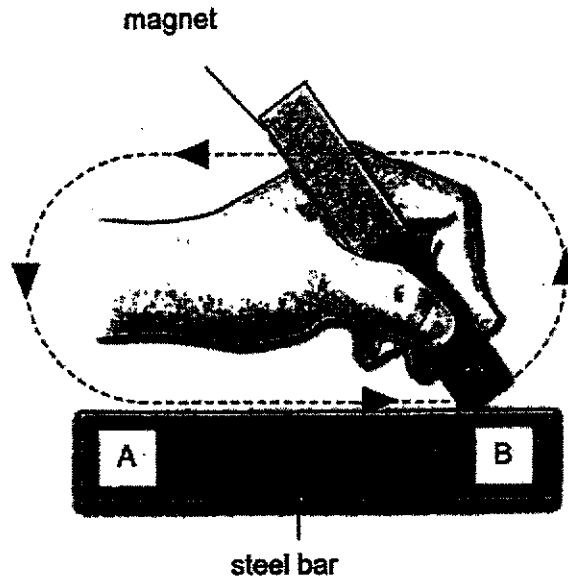

Please do not write in the margin.

Please do not write in the margin.

Aden used the stroke method to make an iron bar into a temporary magnet.

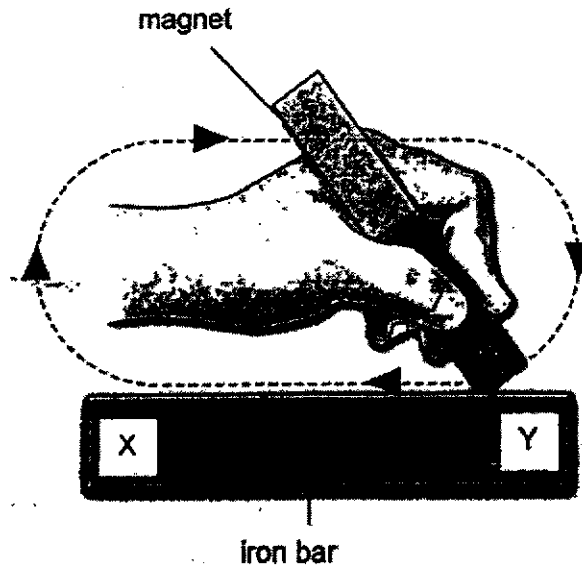

- (a) Name the poles at end X and end Y.

[1]

X: \_\_\_\_\_

Y: \_\_\_\_\_

Aden designed a circuit for a blinking light as shown in the diagram. The moveable metal bar can swing freely about point H.

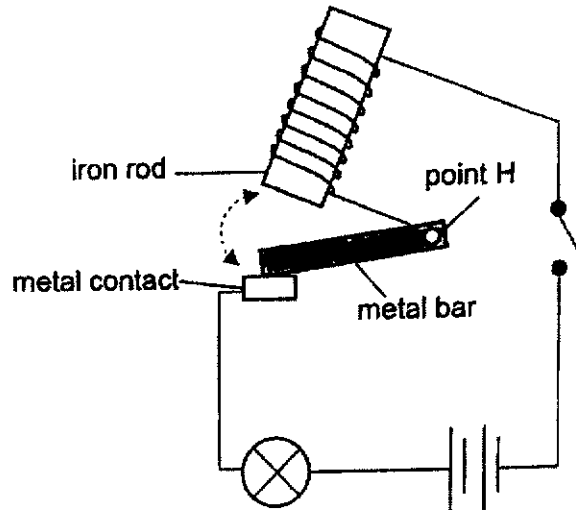

Please do not write in the margin.

Please do not write in the margin.

- (b) Explain why the light bulb blinks repeatedly when Aden closes the switch. [2]

---



---



---

- (c) Apart from adding batteries, suggest another change that Aden could make to the circuit to make the bulb blink faster. [1]

---

- (d) Aden decided to change the iron rod to a magnet. He realised that the bulb did not light up at all. Explain why his circuit could not work after he made the change. [1]

---



---



39. Ansel placed the same volume of hot soup into three identical bags, A, B and C, made of different materials, on a table. He recorded the temperature of the soup in each bag at the start and after an hour.

Bag	Temperature of soup (°C)	
	At the start	After an hour
A	98	70
B	98	87
C	98	76

- (a) State the aim of his experiment.

[1]

---



---

- (b) Which bag, A, B or C should Ansel use if he wants to keep soup warm for the longest time? Explain why.

[2]

---



---



---

- (c) What will happen to the temperature of the soup if the soup is left overnight? Explain why.

[2]

---



---



---

Please do not write in the margin.

Please do not write in the margin.

40. The diagram shows a hydroelectric power station at Location A. The water turns the blades in the turbine so that electricity is produced by the generator.

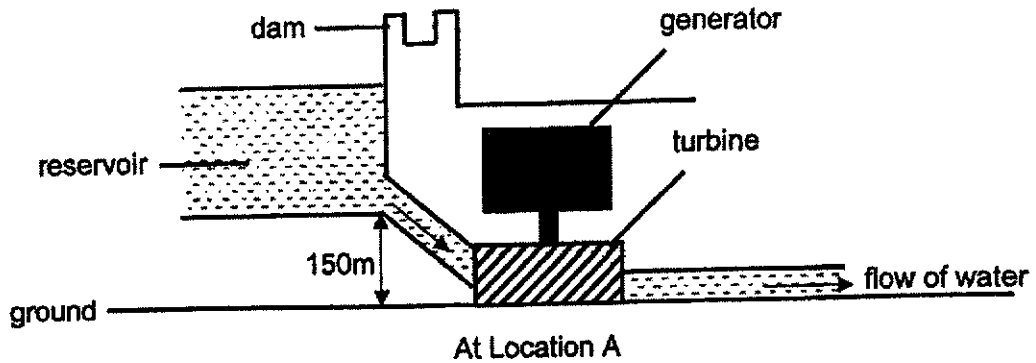

- (a) Fill in the boxes to show the conversion of energy.

[1]

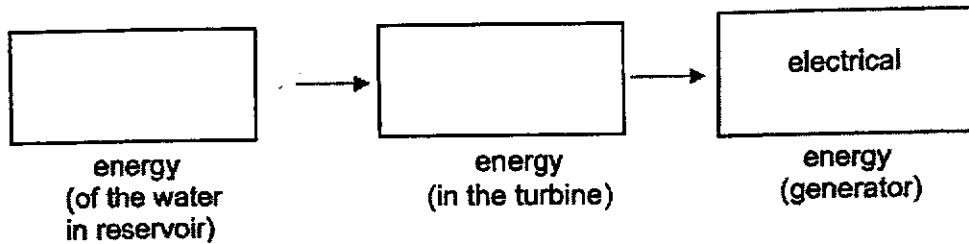

The diagram shows another hydroelectric power station at Location B.

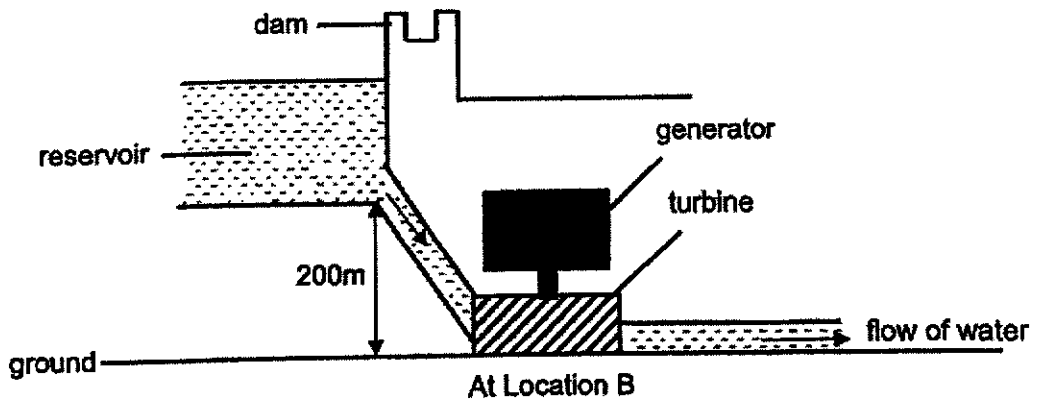

- (b) Both power stations ran for four hours. At which location, A or B, will the power station generate more electricity? Explain your answer.

[2]

---



---



---

- End of Paper -

SCORE	3
-------	---

Please do not write in the margin.

Please do not write in the margin.

**SCHOOL : ACS PRIMARY SCHOOL**  
**LEVEL : PRIMARY 6**  
**SUBJECT : SCIENCE**  
**TERM : Prelims SA2 2022**

---

**SECTION A**

<b>Q 1</b>	<b>Q2</b>	<b>Q3</b>	<b>Q4</b>	<b>Q5</b>	<b>Q6</b>	<b>Q7</b>	<b>Q8</b>	<b>Q9</b>	<b>Q10</b>
<b>3</b>	<b>3</b>	<b>1</b>	<b>2</b>	<b>4</b>	<b>2</b>	<b>3</b>	<b>3</b>	<b>1</b>	<b>1</b>
<b>Q 11</b>	<b>Q12</b>	<b>Q13</b>	<b>Q14</b>	<b>Q15</b>	<b>Q16</b>	<b>Q17</b>	<b>Q18</b>	<b>Q19</b>	<b>Q20</b>
<b>3</b>	<b>2</b>	<b>3</b>	<b>3</b>	<b>4</b>	<b>4</b>	<b>2</b>	<b>1</b>	<b>1</b>	<b>4</b>
<b>Q21</b>	<b>Q22</b>	<b>Q23</b>	<b>Q24</b>	<b>Q25</b>	<b>Q26</b>	<b>Q27</b>	<b>Q28</b>		
<b>2</b>	<b>4</b>	<b>2</b>	<b>3</b>	<b>2</b>	<b>3</b>	<b>3</b>	<b>4</b>		

**SECTION B**

<b>Q29)</b>	<b>a) The surface area of food in contact with the digestive juice.</b> <b>b) Repeat the experiment for both containers three times each and take the average of the three in each container.</b> <b>c) 2g or 2gram</b> <b>d) The rate of digestion increase. Chewing breaks down the food into smaller pieces, increasing the surface area in contact with the digestive juices, that increase the rate of digestion.</b>
<b>Q30)</b>	<b>a) Resting</b> <b>b) Air containing oxygen is inhaled through the nose and is transported to the lungs by the windpipe, the air sacs in the lungs absorbs the oxygen into the blood stream. The oxygenated blood is then pumped by the heart to the arms and legs for respiration to release energy.</b>
<b>Q31)</b>	<b>a) As the sharpness of the pencil tip increase, the depth of piercing also increases.</b>

	<p>b) The roots will pierce and stay in the ground, allowing the roots to be deeper in the muddy soil for it to be able to anchor the seedling into the soil. This increases the chances of seedling growing into a tree.</p> <p>c) The seedlings would have to compete with the parent plant for water, sunlight, space and mineral salts.</p>
Q32)	<p>a) Container B: 6 Container D: 1</p> <p>b) Container C has a plant, water, and a snail, whereas contain A has only water. The snail takes in the dissolved oxygen in the water and gives out carbon dioxide in the process of respiration. However, the plant takes in dissolved carbon dioxide and water and trap light using chlorophyll in the leaves to make food and give out oxygen</p>
Q33)	<p>a) The distance between the two tables. The height of the two tables.</p> <p>b) Flexibility</p> <p>c) Material A. Distance decrease more than B when the same weights were used.</p>
Q34)	<p>a) Evaporation happens at the surface of a liquid while boiling happens throughout the liquid.</p> <p>b) The presence of the wind makes the clothes dry faster.</p> <p>c) The water in the clothes gained heat from the surrounding and evaporated into water vapour. The water vapour then lost heat to the cooler inner surface of the plastic box and condensed to form water droplets.</p>
Q35)	<p>a) As the temperature decreases from 10°C to 4°C, the volume of content decreases. As the temperature decrease from 4°C to 0°C, the volume of the content increases.</p> <p>b) As the water freezes into ice, the water expanded causing the glass bottle to break.</p>
Q36)	<p>a) The bulbs in circuit L are arranged in series. When the amount of bulbs in the circuit increases, the bulbs get dimmer, unlike the bulbs in circuit K which is arranged in parallel.</p>

b) The bulbs in Circuit K are brighter than the bulbs in Circuit L.

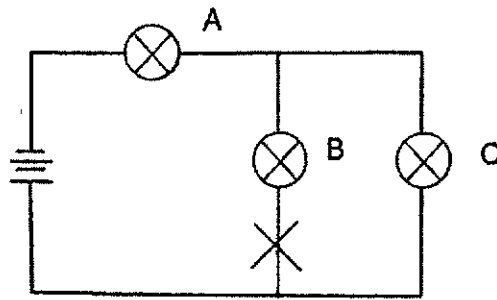

Circuit T

c)

d) Mingzhe could increase the amount of batteries.

Q37)

a) When Adriel lands after the first jump, the spring is extended further than before the first jump thus, there will be more elastic spring force to push him.

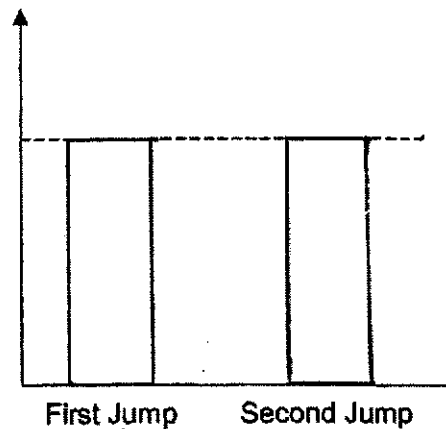

b)

Q38)

a) X: South Y: North

b) When Aden closes the switch, there is a close circuit with the iron rod, allowing electricity to flow through and causing the iron rod to become an electromagnet. The electromagnet acts at a distance and attracts the metal bar. When it attracts the metal bar, there will be an open circuit with the iron rod and does not allow electricity to pass though making the iron bar to no longer be an electromagnet. The metal bar then falls back down and come into contact with the metal contact. The cycle then repeats itself.

c) Coil the wire more times around the iron rod.

	<p>d) The magnet will attract the metal bar, so it is not in contact with the metal contact and there is an open circuit and did not allow electricity to pass through thus this circuit could not work.</p>
Q39)	<p>a) The aim is to find how the different materials affect the temperature of the soup.</p> <p>b) Bag B. The soup in bag B remained the warmest after 1 hour because it lost heat to the surrounding the slowest as it is the poorest conductor of heat.</p> <p>c) The temperature of the soup will decrease to room temperature as the soup did not lose heat or gain heat from the surrounding.</p>
Q40)	<p>a) Gravitational potential <math>\longrightarrow</math> Kinetic</p> <p>b) Location B. The height of the reservoir above the turbine is higher at B than at A so the water there will possess more gravitational potential energy and will be converted to more kinetic energy in the moving water, and convert more kinetic energy in the turbine and more electrical energy on the generator, generating more electricity.</p>