



**HENRY PARK PRIMARY SCHOOL  
PRELIMINARY EXAMINATION 2022**

**PRIMARY 6**

**SCIENCE**

**SECTION A (56 MARKS)**

**INSTRUCTIONS TO CANDIDATES**

1. Do not turn over this page until you are told to do so.
2. Follow all instructions carefully.
3. Answer all questions.
4. Shade your answers on the Optical Answer Sheet (OAS) provided.

Name: \_\_\_\_\_ (    )

Class: Primary 6 (    )

Date: 23 August 2022

Total Time for Sections A and B: 1 h 45 min

<b>Sections</b>	<b>Marks</b>
<b>A</b>	<b>/ 56</b>
<b>B</b>	<b>/ 44</b>
<b>Total</b>	<b>/ 100</b>

Parent's Signature: \_\_\_\_\_



**Booklet A (58 marks)**

**For each question from 1 to 28, four options are given. One of them is the correct answer. Make your choice (1, 2, 3 or 4). Shade the correct oval (1, 2, 3 or 4) on the Optical Answer Sheet.**

1. Some animals are classified into four groups, A, B, C and D, as shown in the table below.

	has wings	has no wings
lays eggs	A	B
does not lay eggs	C	D

The diagrams show animals M and N.



Animal M



Animal N

Based on the information given, which of the following classification of animals M and N is correct?

	Animal M	Animal N
(1)	A	C
(2)	C	A
(3)	B	C
(4)	D	B

2. Study the two groups of animals shown below.

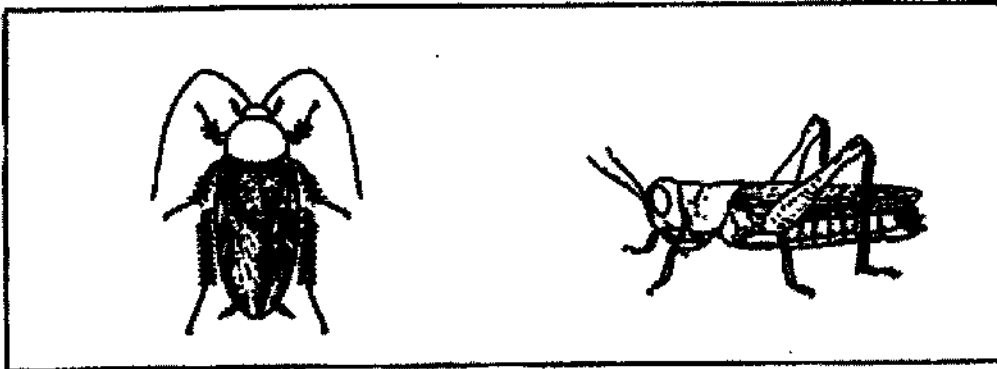

Group E

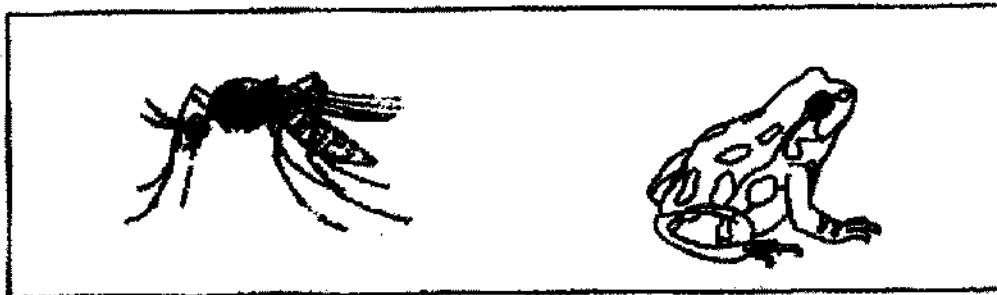

Group F

Which of the following describes the animals in groups E and F correctly?

	Group E		Group F	
	Lays eggs in water	Young resembles the adult	Lays eggs in water	Young resembles the adult
(1)	Yes	No	No	Yes
(2)	No	Yes	Yes	No
(3)	Yes	Yes	No	No
(4)	No	No	Yes	Yes

3. The diagram shows how food travels in the digestive system.

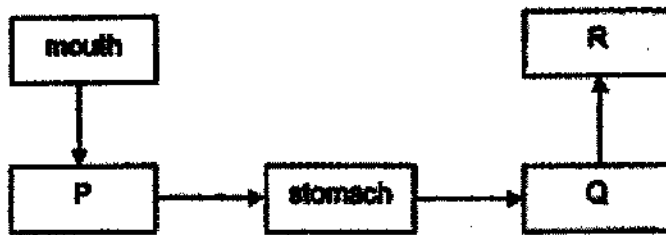

Based on the diagram, which of the following is correct?

	small intestine	gullet
(1)	Q	P
(2)	R	P
(3)	R	Q
(4)	Q	R

4. Molly conducted an experiment to investigate gaseous exchanges in a leaf as shown below.

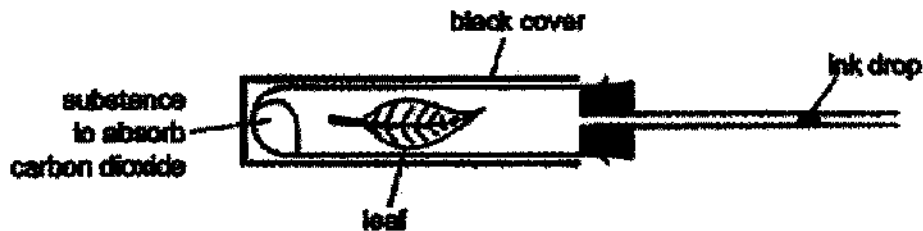

Based on the information given, which of the following is correct?

	direction ink drop moves	gas exchange taking place in the leaf
(1)	→	taking in oxygen, giving out carbon dioxide
(2)	←	taking in carbon dioxide, giving out oxygen
(3)	←	taking in oxygen, giving out carbon dioxide
(4)	→	taking in carbon dioxide, giving out oxygen

5. Study the diagram below. A, B, C and D are blood vessels.

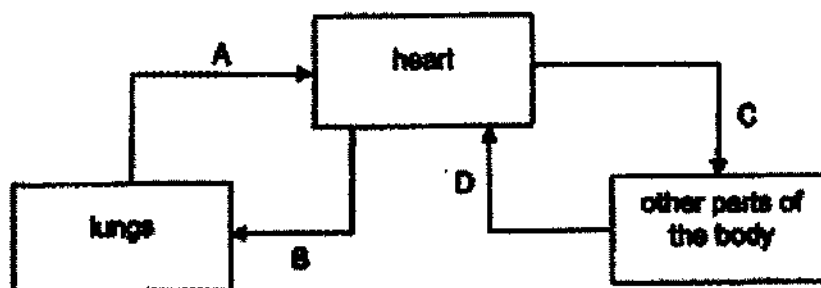

Which one of the statements below is correct?

- (1) The blood in A is rich in oxygen.
- (2) The blood in C does not carry any carbon dioxide.
- (3) The blood in B has more oxygen than the blood in C.
- (4) The blood in D has less carbon dioxide than the blood in A.

6. The diagram below shows a cross-section of the male part of a flower which produces the male reproductive cells.



What are J and K?

	J	K
(1)	ovule	ovary
(2)	ovule	anther
(3)	pollen grain	anther
(4)	pollen grain	ovary

7. The diagrams below show the two cells involved in the reproduction of humans.



Cell X



Cell Y

Which of the following table gives the correct information about cells X and Y?

(1)

Information	Cell X	Cell Y
Name of cell	egg	sperm
Where is it produced?	ovary	testis

(2)

Information	Cell X	Cell Y
Name of cell	egg	sperm
Where is it produced?	testis	ovary

(3)

Information	Cell X	Cell Y
Name of cell	sperm	egg
Where is it produced?	testis	ovary

(4)

Information	Cell X	Cell Y
Name of cell	sperm	egg
Where is it produced?	ovary	testis

8. The diagram below shows the similarities and differences between a human cheek cell and a hydrilla leaf cell.

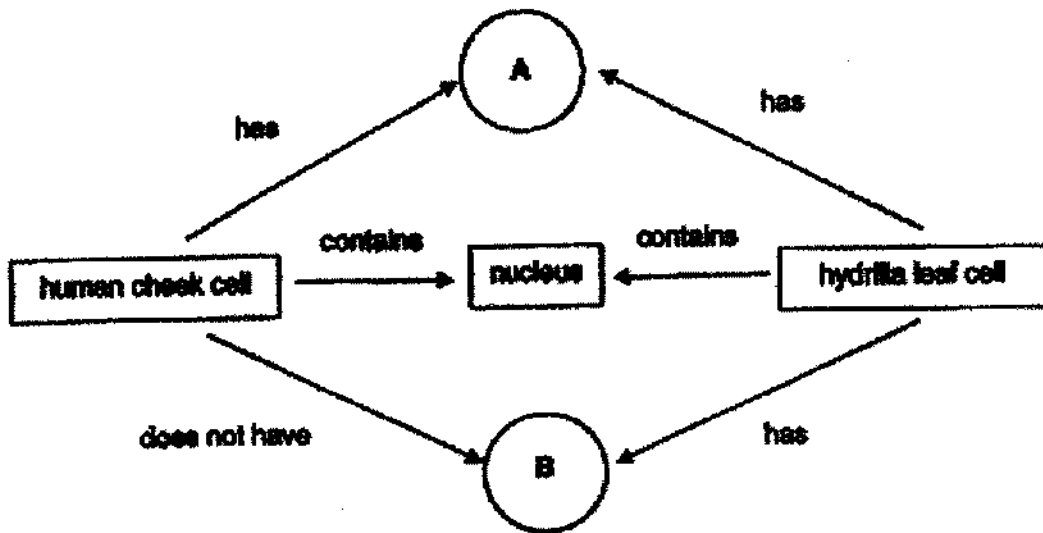

Which one of the following correctly represents A and B?

	A	B
(1)	cytoplasm	cell membrane
(2)	chloroplast	cell membrane
(3)	cell wall	chloroplast
(4)	cell membrane	cell wall



9 Study the flowchart below.

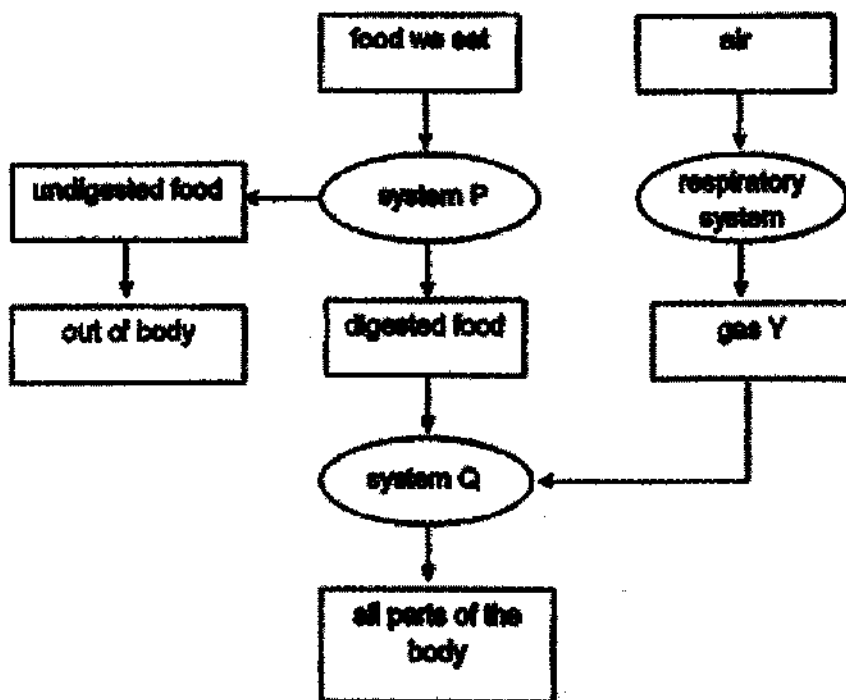

Which of the statements below is/are correct?

- A Gas Y is oxygen.
- B System Q is involved in gaseous exchange.
- C System P is involved in the absorption of simple substances.

- (1) A only
- (2) A and C only
- (3) B and C only
- (4) A, B and C

10 The diagram below shows the school pond.

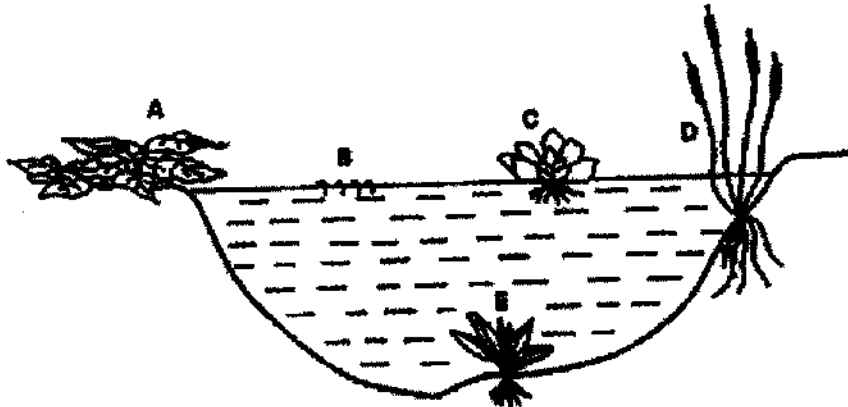

When the population of plant C increased, how will the rest of the plants most likely be affected?

Observation	
(1)	Only the population of plant E will decrease, the rest of the plants remain the same.
(2)	Both the population of plant B and E will decrease, plant A and D will remain the same.
(3)	The population of plant A and D will increase but plant B and E will decrease.
(4)	The population of plant B and E will increase, plant A and D will remain the same.

11. Raju wanted to study the quality of the water at the upper stream and lower stream of the river shown in the diagram below.

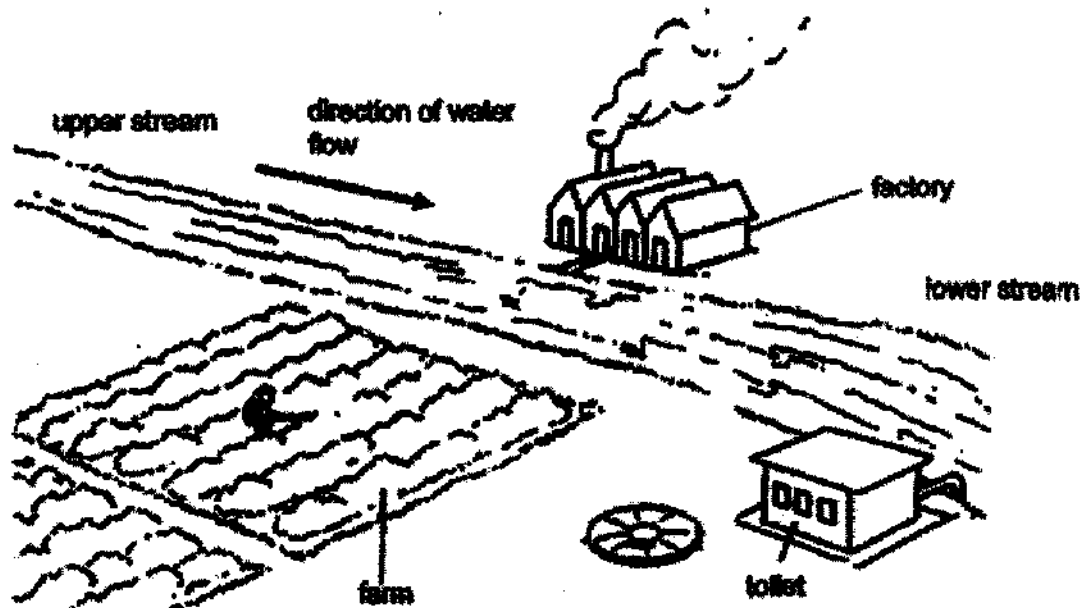

He placed a coin at the bottom of a container. Then he poured water from the upper stream into the container until the coin could no longer be seen from the top. He measured the height  $h$  of the water.

He repeated the experiment with the water from the lower stream using another similar container and coin.

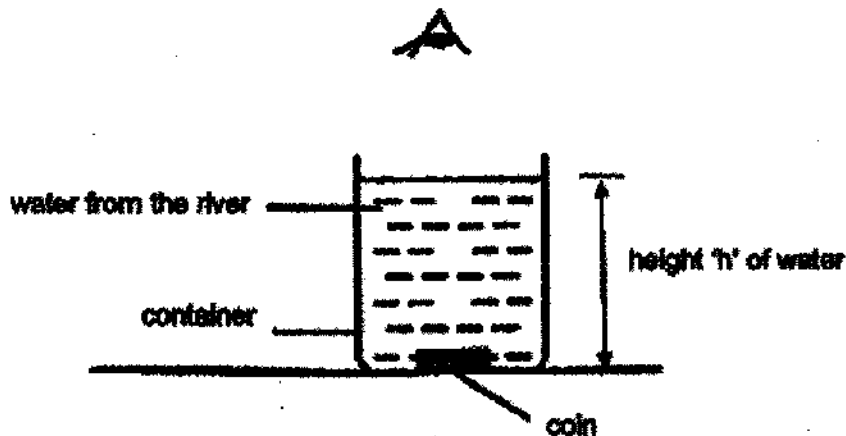

Question 11 continues on the next page

Question 11 continued

Which of the following graphs shows correctly his observation?

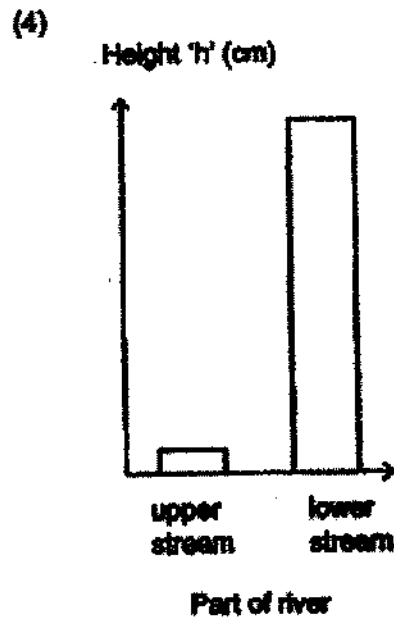
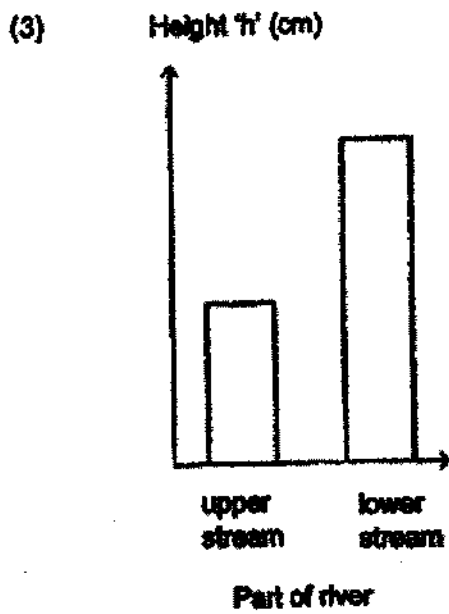
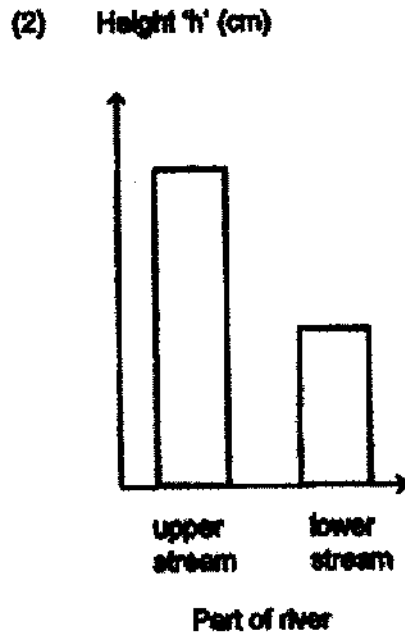
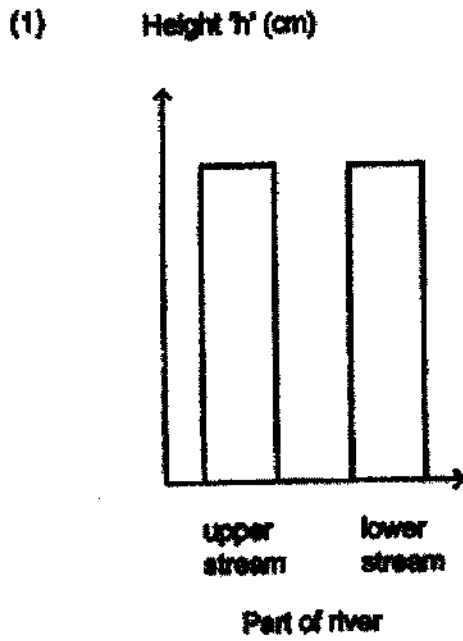

12. Study the food web shown below.

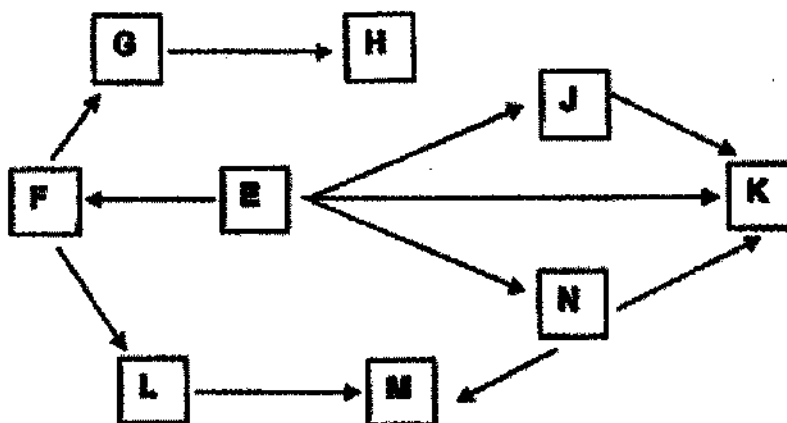

Based on the food web, which of the following statement(s) is/are correct?

- A E is a food producer.
- B H, K and M are predators.
- C F, J, K and N are herbivores.
- D G and L are both predator and prey.

- (1) A only
- (2) A and C only
- (3) A, B and D only
- (4) B, C and D only

13. In a leaf litter community, the population of decomposers will likely increase if the

- A habitat is more moist
- B rotting leaves become dry
- C exposure to sunlight is greater
- D air inside it has more water vapour

- (1) A and C only
- (2) A and D only
- (3) B and C only
- (4) A, B and C only

14. Anna saw bird P perching on a branch and feeding by cracking a nut. The diagram below shows the beaks and feet of some birds.

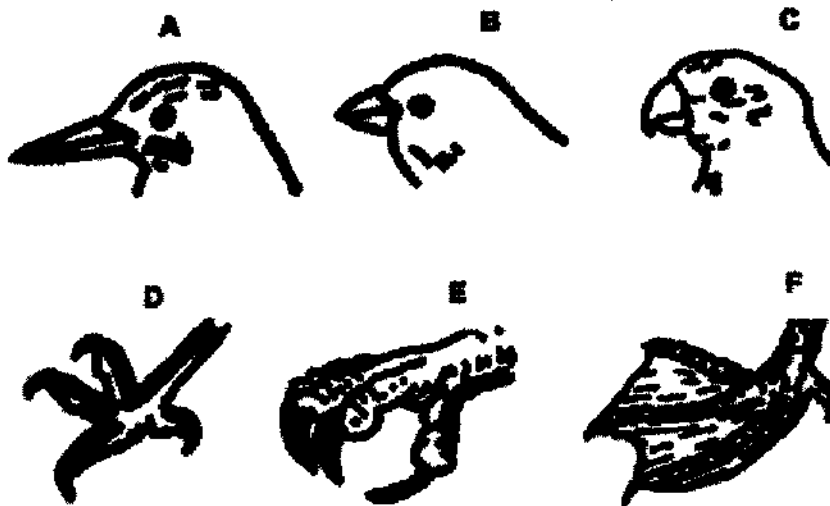

Which type of beak and feet shown above most likely belong to bird P?

	Beak	Feet
(1)	A	E
(2)	B	F
(3)	B	D
(4)	C	D

15. Megan conducted some experiments to find out more about the properties of materials X and Y. The diagrams show the experiments she conducted and what she observed.

**Material X**

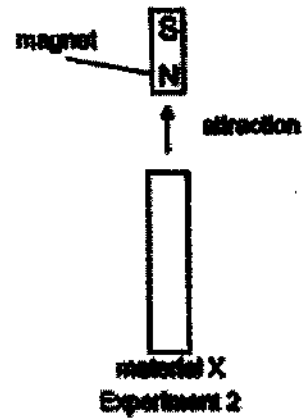
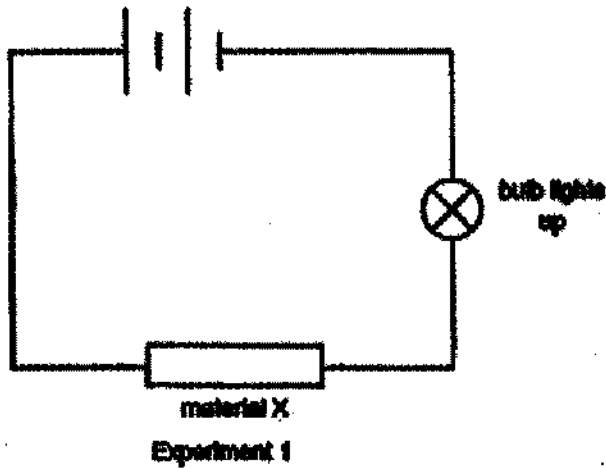

**Material Y**

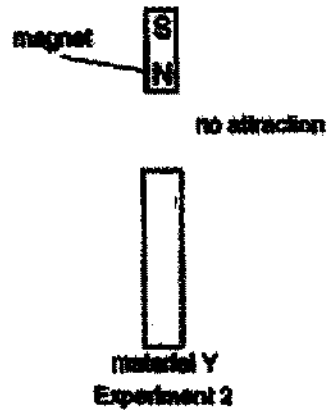
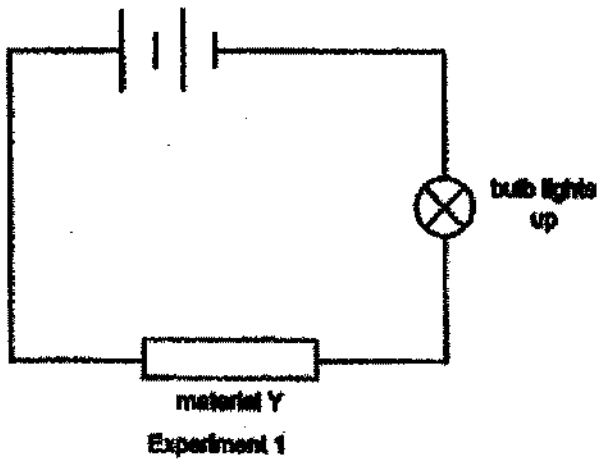

Based on the results of the experiment, which of the following is correct?

	Material X	Material Y
(1)	aluminium	glass
(2)	aluminium	steel
(3)	steel	aluminium
(4)	steel	glass

16. Sue measured the temperature of the water before and after heating it.

Diagram X shows the temperature of the water before it was heated. Diagram Y shows the temperature of the water after it was heated.



Diagram X



Diagram Y

By how much did the temperature of the water rise after it was heated?

- (1) 25°C
- (2) 30°C
- (3) 50°C
- (4) 55°C



17. Betty poured 250 ml of cold water measuring  $10^{\circ}\text{C}$  into 4 similar containers, W, X, Y and Z, made of different materials. The containers were left near an open window during the experiment.

After 5 minutes, the temperature of the water in each container is measured and recorded in the bar graph shown below.

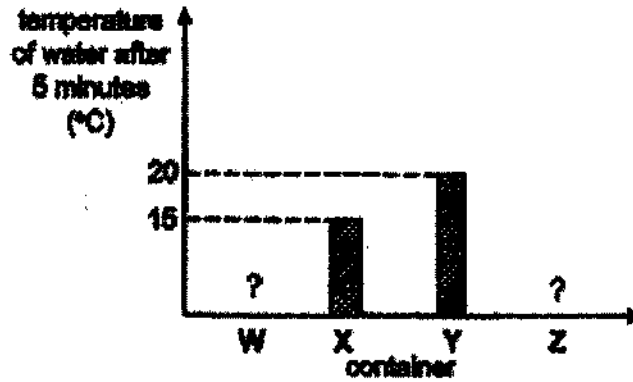

Based on the results, Betty concluded that material W is the best conductor of heat and material Z is the poorest conductor of heat.

What will be the likely temperature of water in the containers made of materials W and Z after 5 minutes?

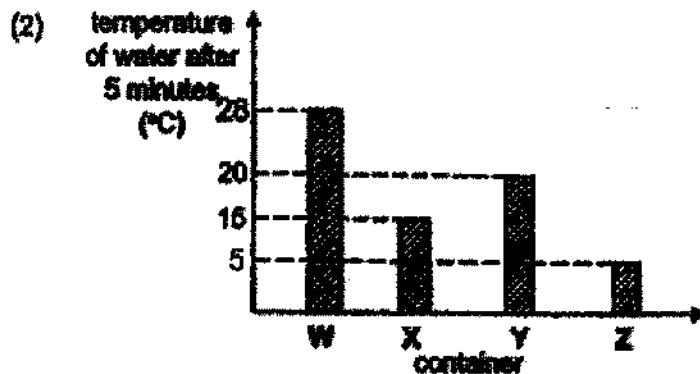
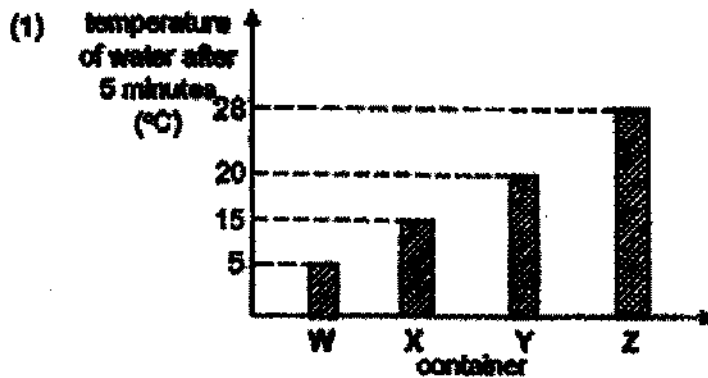

Question 17 continued

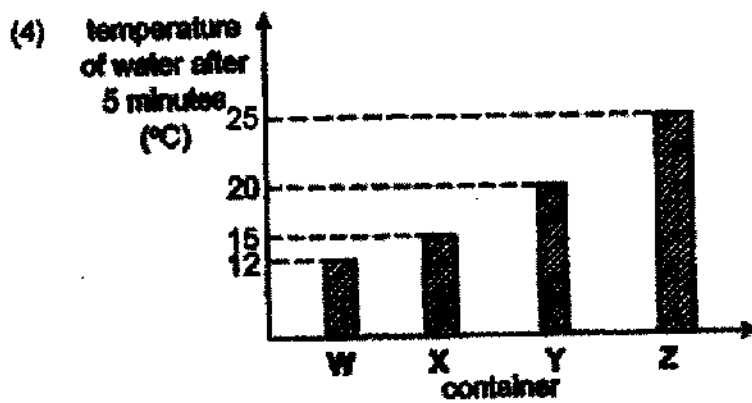
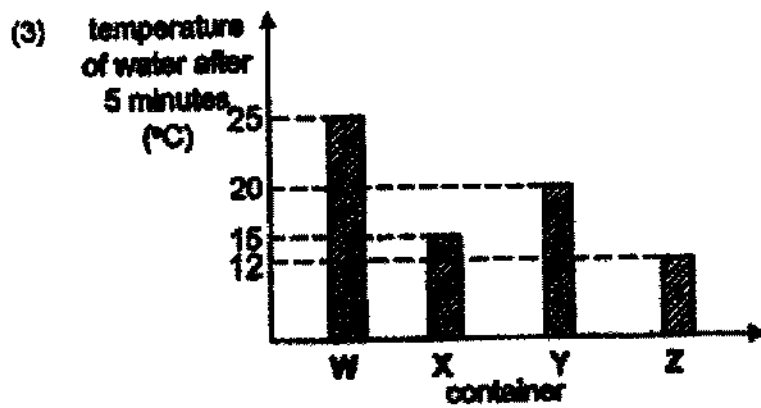

18. Dorothy used two wooden blocks, E and F, of different heights to investigate the length of shadows.

The diagram shows the shadows of blocks E and F projected on a screen during Dorothy's experiment.



Shadows on the screen

Based on the diagram given above, which of the following shows Dorothy's experimental set-up?

(1)

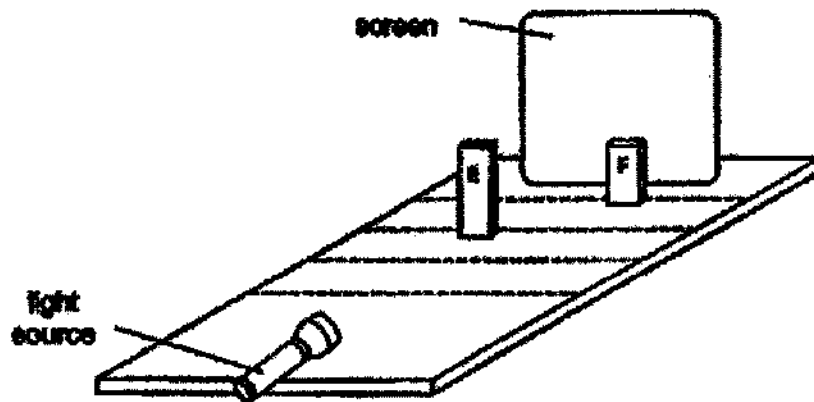

(2)

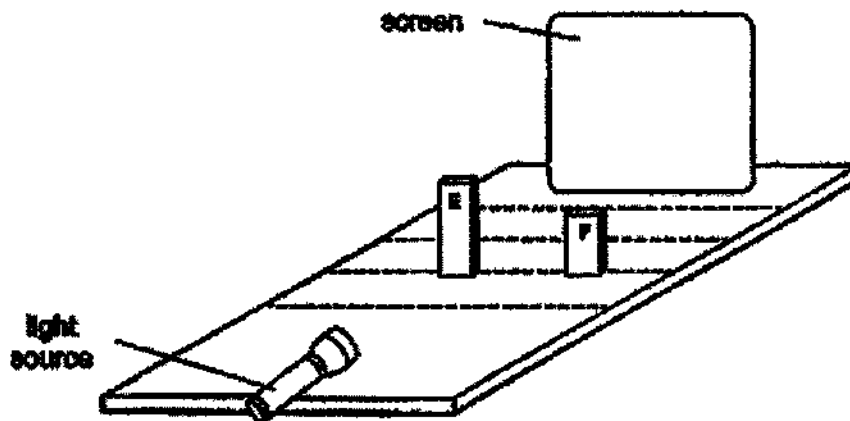

Question 18 continued

(3)

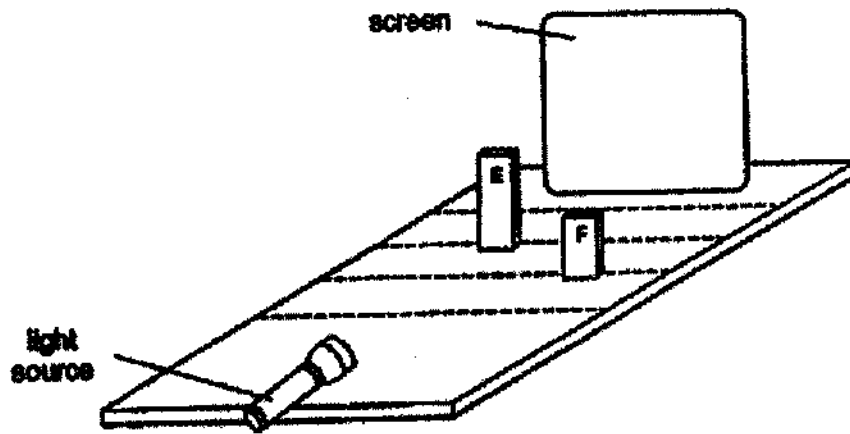

(4)

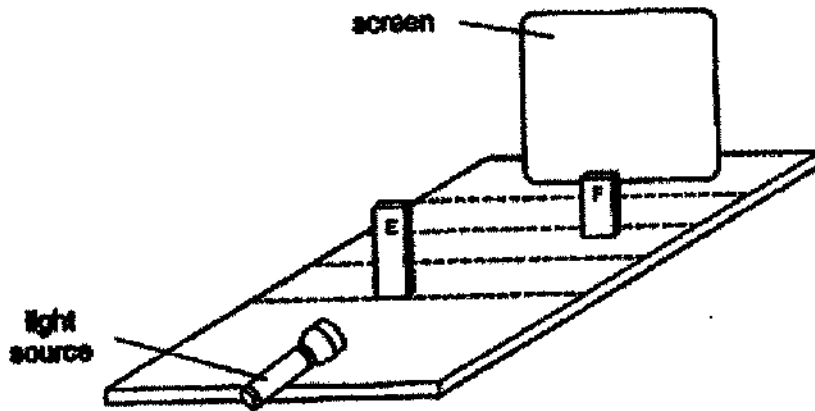

19. The diagram below shows a deflated balloon fixed to an air pump.

Mani placed the balloon in a cylinder and then filled the cylinder with water to the brim.

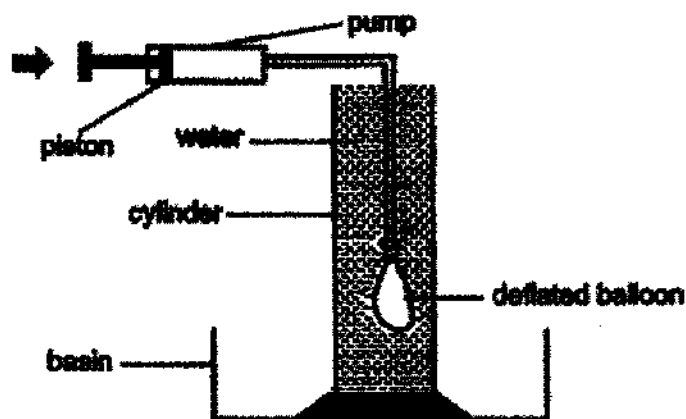

To pump  $100 \text{ cm}^3$  of air into the deflated balloon, Mani tried to push the piston into the pump.

Which of the following will be observed?

- A The balloon will inflate.
- B The piston cannot be pushed.
- C Water in the cylinder will overflow.
- D Volume of water in the cylinder remains the same.

- (1) A only
- (2) B only
- (3) A and C only
- (4) B and D only

20. Study the flowchart below.

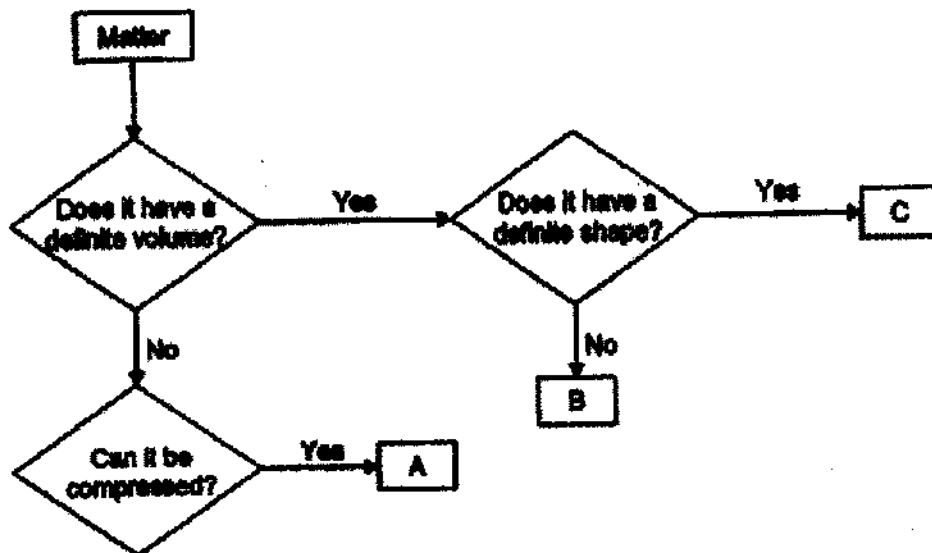

What can A, B and C be?

	Solid	Liquid	Gas
(1)	A	B	C
(2)	B	C	A
(3)	C	B	A
(4)	C	A	B

21. Junlong conducted an experiment using the set-up shown below.

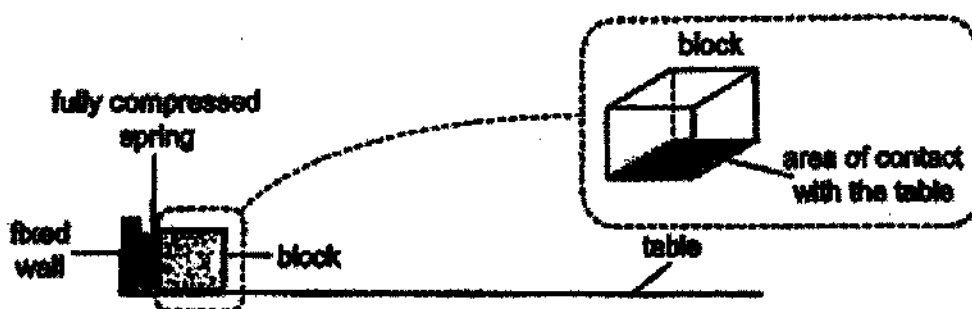

He measured the distance the block moved after releasing the spring.

He repeated the experiment using blocks made of the same material, but with different mass and area of contact with the table.

His results are shown below.

Block	Mass (g)	Area of contact with the table (cm <sup>2</sup> )	Distance moved (cm)
F	30	100	12
G	40	100	9
H	40	150	9

Based on the results given, which of the following statements are correct?

- A The mass of the block affects the distance moved.
- B The mass of the block does not affect the distance moved.
- C The area of contact with the table affects the distance moved.
- D The area of contact with the table does not affect the distance moved.

- (1) A and C
- (2) A and D
- (3) B and C
- (4) B and D

22. All constructed the electric circuit as shown below.

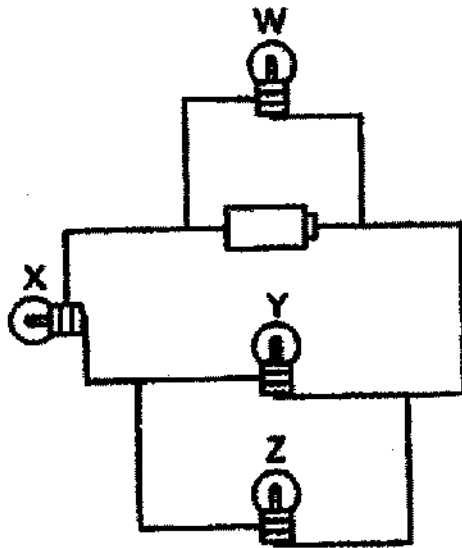

Which one of the following is correct?

	Bulb fuses	Bulb(s) that can still light up
(1)	W	X only
(2)	X	W only
(3)	Y	X and Z only
(4)	Z	X and Y only



23. Jordan set up the experiment as shown below using two identical beakers, A and B. After 30 minutes, beaker A has less water than beaker B. Jordan concludes that the presence of wind increases the rate of water evaporating.

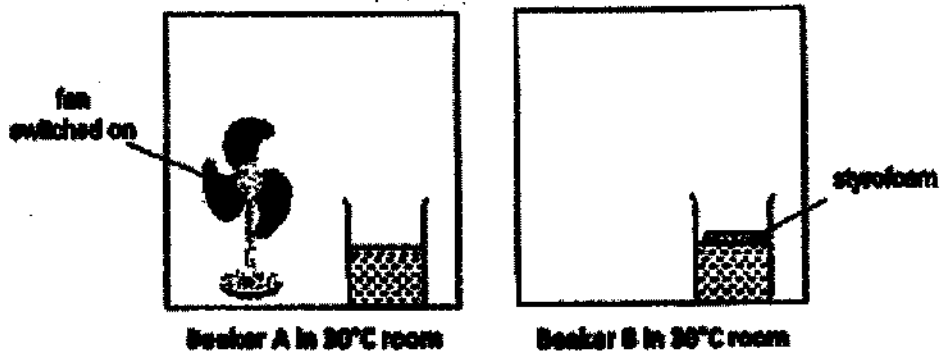

Jordan's science teacher told him that he should make some changes to his control set-up.

How can Jordan improve his experiment?

- A Remove the styrofoam from beaker B.
- B Place two fans that are switched on beside beaker B.
- C Place beaker A outdoors and place beaker B indoors.

- (1) A only
- (2) B only
- (3) A and B only
- (4) A, B and C

24. The diagram below shows a ball travelling along a circular track.

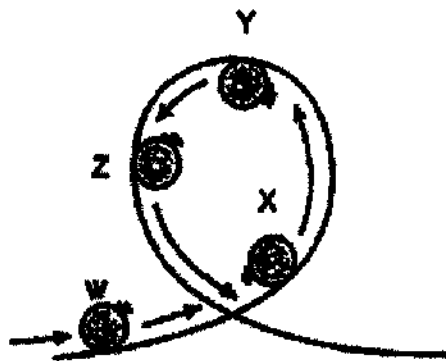

All made the following statements about the set-up.

- A There is more gravitational force at Y than at Z.
- B There is more potential energy than kinetic energy at Y.
- C At X, kinetic energy is increasing while potential energy is decreasing.

Which of the above statements is / are correct?

- (1) A only
- (2) B only
- (3) A and B only
- (4) B and C only

25. Jonathan used a sharp pin to pierce an inflated balloon and it burst into several pieces with a loud 'pop' sound as shown below.



Which of the following correctly shows the energy conversion in the balloon?

- (1) Kinetic energy  $\longrightarrow$  Sound energy + Heat energy
  - (2) Kinetic energy  $\longrightarrow$  Potential energy + Heat energy
  - (3) Potential energy  $\longrightarrow$  Kinetic energy + Sound energy
  - (4) Potential energy  $\longrightarrow$  Kinetic energy + Heat energy
26. What is/are the force(s) acting on the wooden ball as it rolls down the ramp?

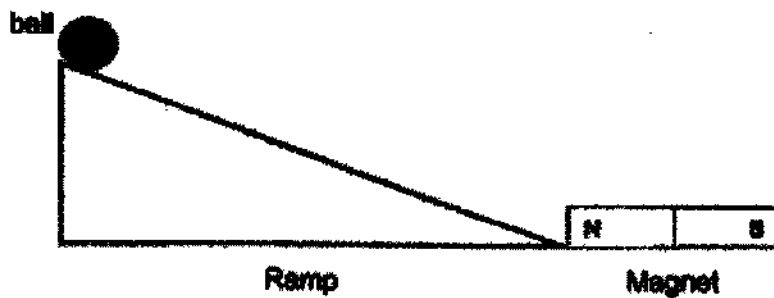

- A Frictional force
  - B Magnetic force
  - C Gravitational force
- (1) A only
  - (2) B only
  - (3) A and C only
  - (4) A, B and C

27. Stephen set up an experiment as shown in the diagrams below.

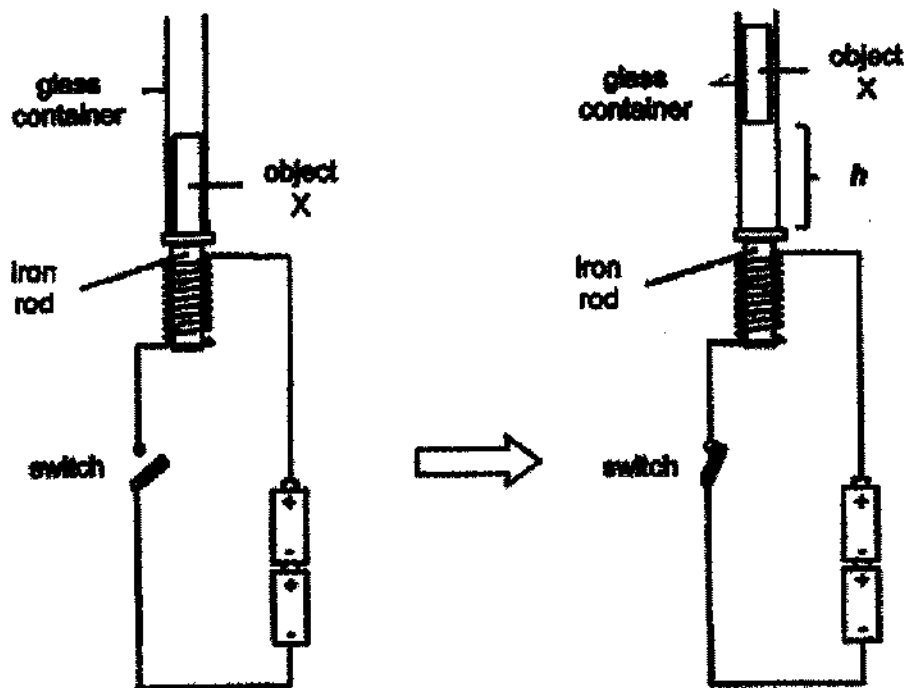

When the switch is closed, object X moves up the glass container.

Which one of the following statements is correct?

- (1) Distance  $h$  decreases with more batteries in the circuit.
- (2) There is no force acting on object X when the switch is open.
- (3) There is only frictional force acting on object X when the switch is open.
- (4) There are magnetic and gravitational forces acting on object X when the switch is closed.

28. Lucas conducted an experiment on springs A and B. He hung different loads, one at a time, and measured the length of the spring. His results are shown in the graph below.

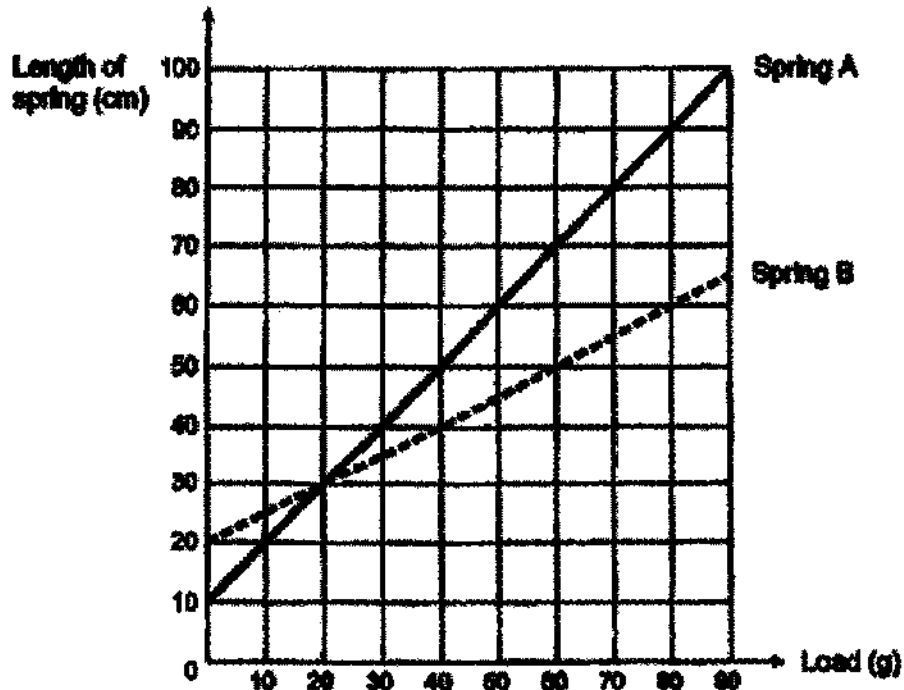

Which one of the following statements is correct?

- (1) Spring A is stiffer than spring B.
- (2) Spring B extends more than spring A when the load is 10g.
- (3) Spring A is longer than spring B when no load is hung on it.
- (4) Spring A and spring B have the same length when the load is 20 g.

**END OF BOOKLET A**





**HENRY PARK PRIMARY SCHOOL  
PRELIMINARY EXAMINATION 2022**

**PRIMARY 6**

**SCIENCE**

**SECTION B (44 MARKS)**

**INSTRUCTIONS TO CANDIDATES**

1. Do not turn over this page until you are told to do so.
2. Follow all instructions carefully.
3. Answer all questions.

Name: \_\_\_\_\_ (    )

Class: Primary 6 (    )

Date: 23 August 2022

Total Time for Sections A and B: 1 h 45 min

Marks for Section B: \_\_\_\_\_





**Booklet B (44 marks)**

Write your answers to questions 29 to 41 in the spaces given.

29. The diagram shows parts of a flowering plant and their functions.

Parts of a flowering plant				
leaf	G	fruit	H	stem
makes food	holds the plant firmly to the ground	protects the seed	helps the plant to reproduce	(b)

- (a) What are the parts labelled G and H in the diagram above? [1]

Part G: \_\_\_\_\_

Part H: \_\_\_\_\_

- (b) State one function of the stem. [1]

\_\_\_\_\_

\_\_\_\_\_

**Please do not write in the margin.**

30. The diagram shows the lifecycle of a butterfly.

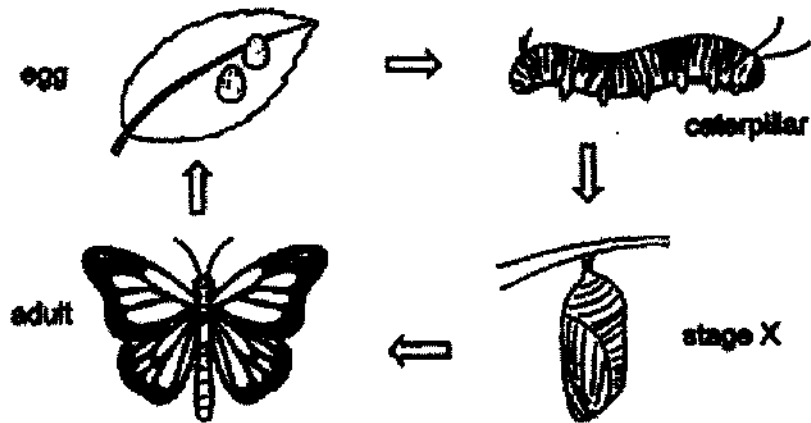

- (a) Name stage X.

[1]

Fruit trees, vegetables and butterflies make up a community in a farm.

The farmer sprayed pesticide on the vegetables when he found that they were eaten by caterpillars.

- (b) State and explain how the use of the pesticide would affect the number of fruits produced in the farm. [2]

---



---



---

**Please do not write in the margin.**

31. The diagram shows animal Y.



- (a) Is animal Y an insect? Give a reason for your answer.

[1]

Raj wanted to find out the suitable living conditions for animal Y. He set up a tray as shown below.

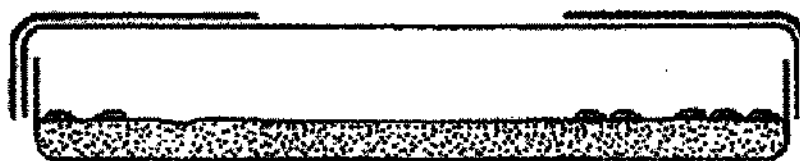
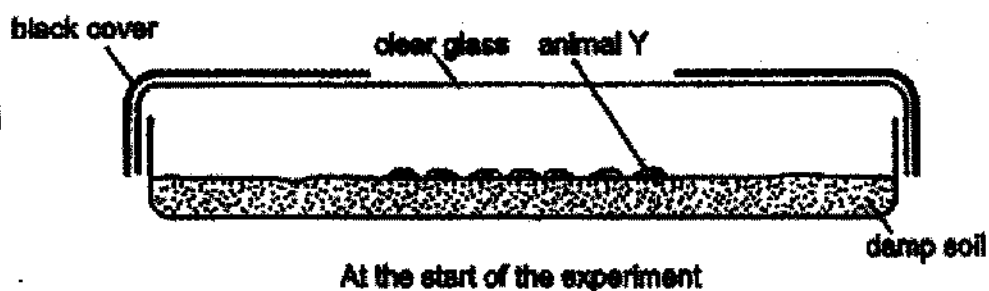

- (b) From the results, state one characteristic of living things observed from animal Y's behaviour. [1]

- (c) After setting up the experiment, Raj waited for 30 minutes before recording the results. Explain why. [1]

- (d) Explain how the behaviour of animal Y would help them to survive in their natural habitat. [1]

**Please do not write in the margin.**

32. Rainer set up three experiments as shown below.

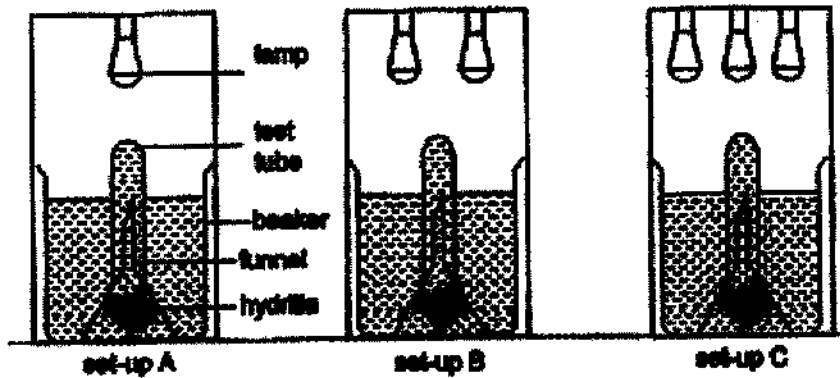

- (a) After 30 minutes, there were bubbles produced by the hydrilla. Name the gas collected in the test tube. [1]

---

- (b) Which set-up will have the most volume of gas collected in the test tube? [1]  
Give a reason for your answer.

---



---

- (c) Suggest another way Rainer could increase the volume of the gas collected in the test tubes. [1]

---



---

- (d) How can Rainer increase the accuracy of the results obtained? [1]

---



---

**Please do not write in the margin.**

33. The diagrams show birds X and Y.



Bird X



Bird Y

Bird X lives in the wild as well as in the cities. Bird Y lives only in the wild and feeds on bird X.

The graph below shows the population of bird X over 5 years in the wild as well as in the cities.

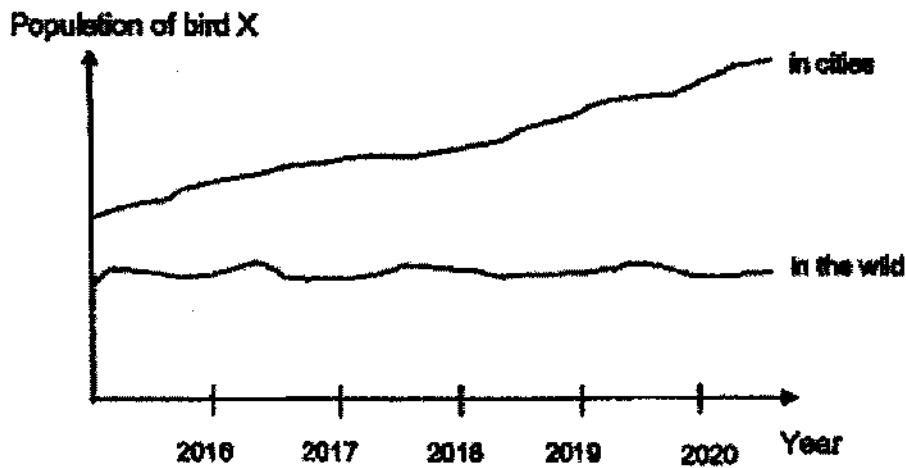

- (a) Based on the graph, how does the presence of bird Y affect the population of bird X? [1]

---



---

Question 33 continues on the next page

Please do not write in the margin.

## Question 33 continued

Bird X spreads diseases through their waste matter and dust from their feathers. The authorities in the cities decrease the population of bird X by:

(i)



putting up signs to discourage people from feeding X

(ii)

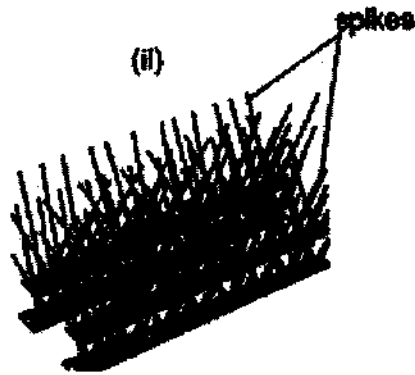

putting spikes on the roof of buildings where bird X builds nests

(b) Explain how the two actions help to decrease the population of bird X. [2]

(i)

---



---

(ii)

---



---

**Please do not write in the margin.**

34. Organism L, shown below is made up of algae and fungi living together. The algae has chlorophyll while the fungi traps water and mineral salts.

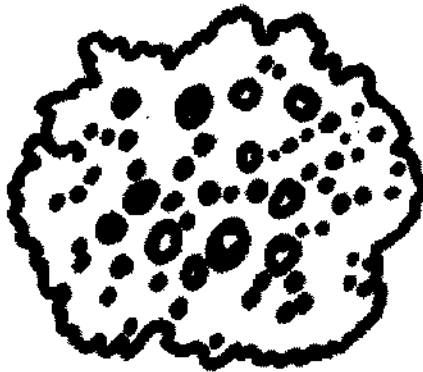

organism L

- (a) How does the algae and fungi benefit each other? [2]

Benefit for algae:

---

---

---

Organism L is commonly found on tree trunks as shown below. It is easily harmed by pollutants in the air.

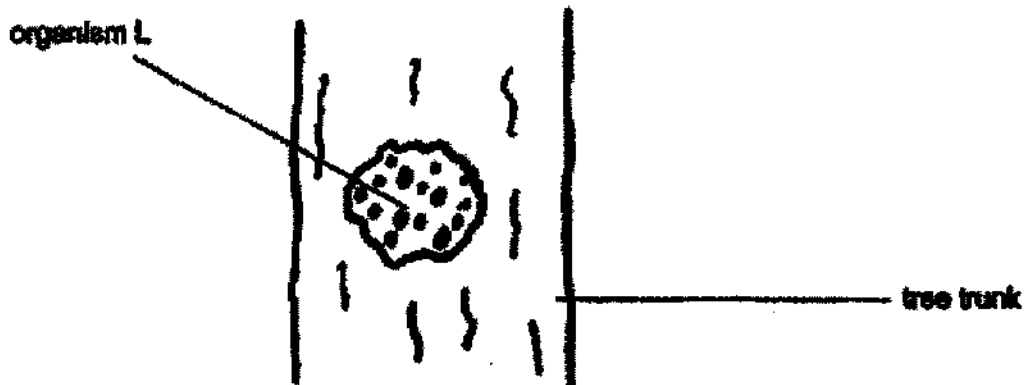

Question 34 continues on the next page

**Please do not write in the margin.**

Question 34 continued

The graphs below show the number of factories and the population of organism L in city A over a period of five years.

Number of factories

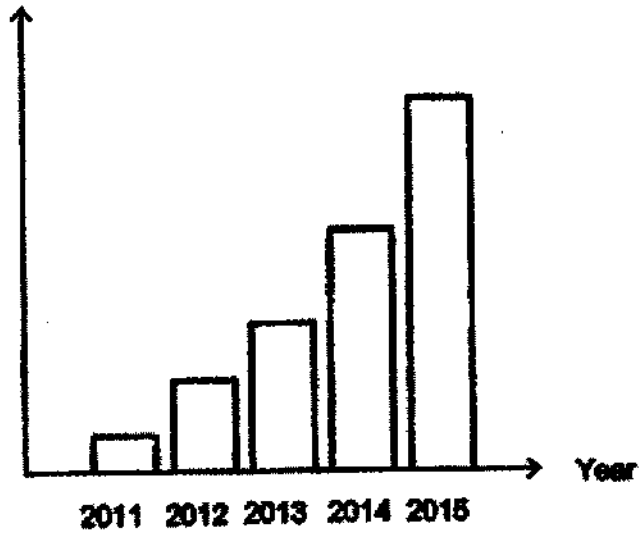

Population of organism L

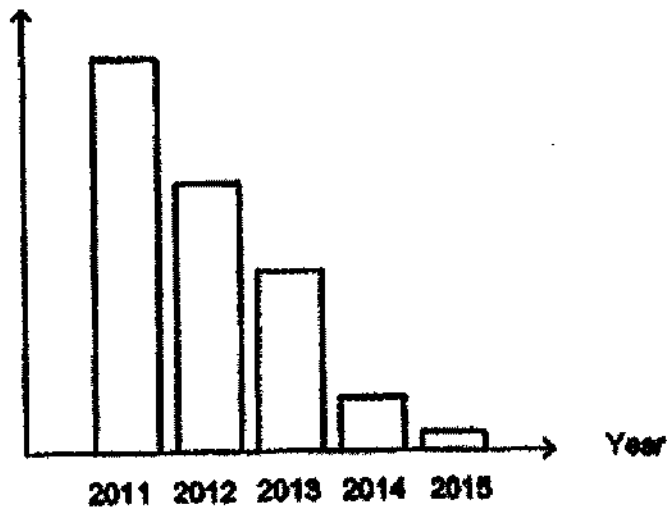

- (b) Explain how the change in the number of factories in city A caused the change in the population of organism L. [2]

---

---

---

**Please do not write in the margin.**



35. The diagram shows the larva of insect M.



- (a) How many stages are there in the life cycle of insect M? [1]  
Give a reason for your answer.

---



---

The larva of insect M makes a case with two openings. It can curl its body in the case and emerge at either end of the openings as shown below.

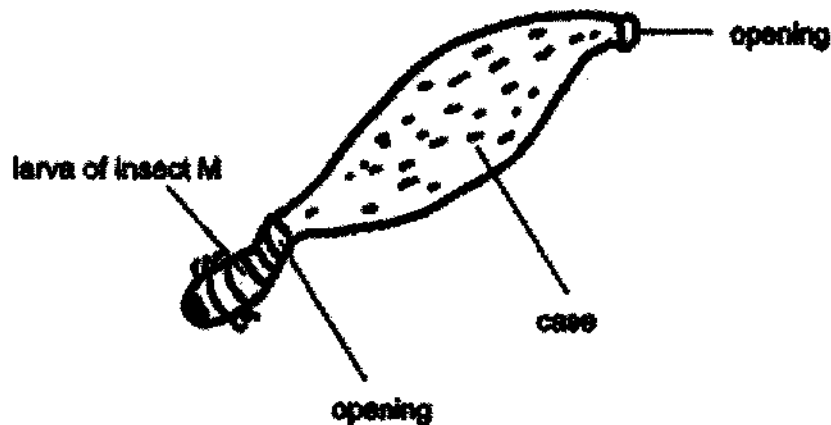

- (b) The larva remains in the case most of the time and carries the case with it everywhere it goes. How does this behaviour ensure its survival? [1]

---

**Please do not write in the margin.**

36. Lee designed a toy as shown in the diagram below.

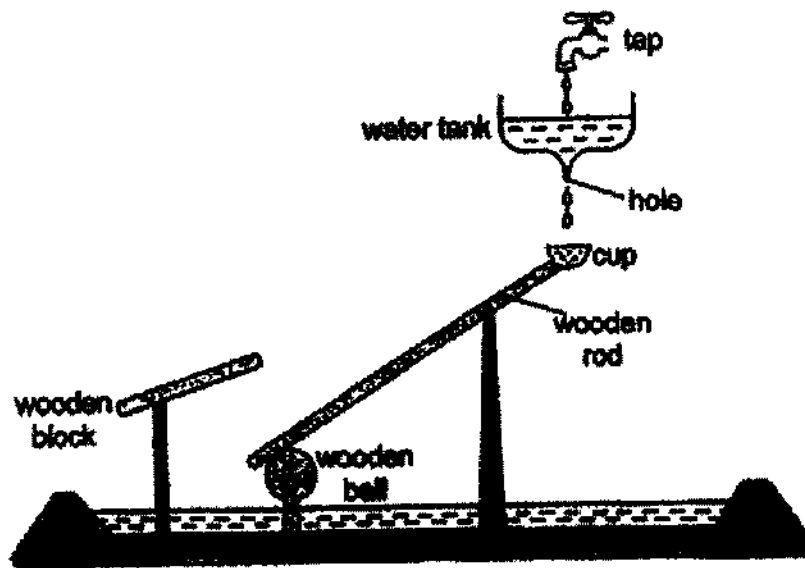

Water from the tank dripped into the cup that was fixed onto a wooden rod.

When the cup was filled up with water, it moved down. This in turn caused the other end of the wooden rod to move up and hit the wooden block.

Lee could hear a 'click' when the two wooden surfaces hit each other.

- (a) Explain how the cup was emptied and refilled with water. [2]

---



---



---

- (b) Describe the change Lee would observe if he were to make the hole in the water tank bigger and water drip out faster. [2]  
Explain your answer.

---



---

**Please do not write in the margin.**

37. Sue was investigating the effects of heat transfer.

She first recorded the temperature of the air in a container as shown in set-up A. Then she placed some hot stones in set-up B and sealed the opening as shown in set-up B.

She measured and recorded the temperature of air in the bottle as shown in set-up B.

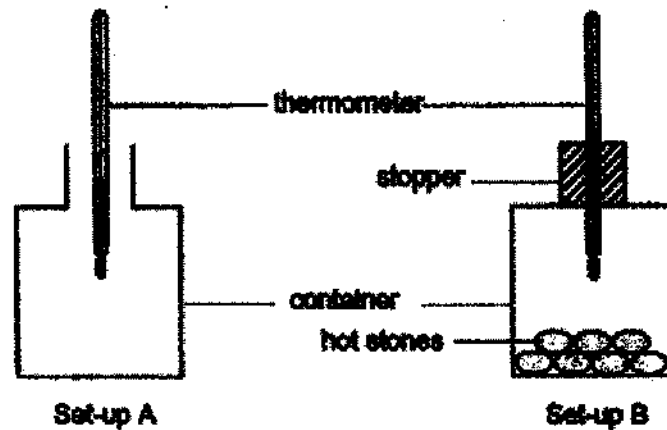

Temperature of air in the bottle ( $^{\circ}\text{C}$ )	
Set-up A	Set-up B
31	37

- (a) What happens to the temperature of air measured if the thermometer is placed closer to the hot stones in set-up B? [1]  
Give a reason for your answer.

---



---

- (b) A refrigerator uses electrical energy to keep the temperature inside at  $10^{\circ}\text{C}$ .  
This will keep the food in the refrigerator cold. Sue's mother told her that she should allow hot food to cool before placing it in refrigerator.

How will this help Sue save electricity? [1]

---



---

**Please do not write in the margin.**

38. Janel built an electrical system for the radio and fan in the diagram below. W is an iron rod with wires coiled around it. P and Q are 2 steel contacts. While P is fixed, Q can move sideways as it is attached to metal rod X which can move as it is on a hinge.

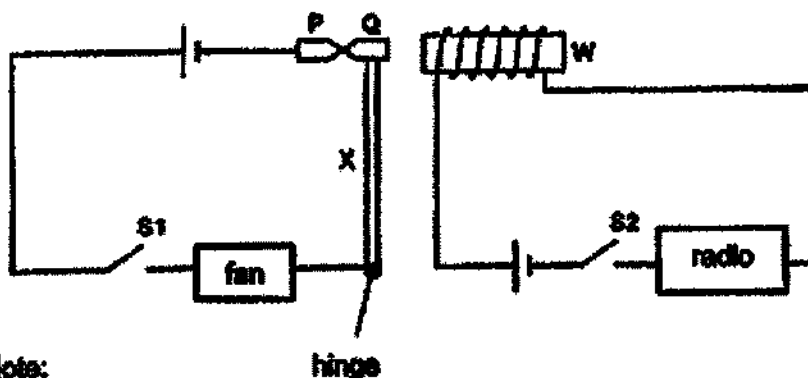

Note:

S1 – switch 1

S2 – switch 2

- (a) Which electrical appliance, fan or radio, will be able to function when S1 is closed and S2 is open? [1]

- (b) When Janel switched on the radio, can she switch on the fan at the same time? Explain your answer. [2]

Janel made the following statement.

If steel contact Q is replaced with a magnet, I can switch on both the fan and the radio at the same time.



Janel

Question 38 continues on the next page

Please do not write in the margin.

**Question 38 continued**

**(c) Explain why**

**(i) Janel could be wrong.**

**[1]**

---

---

**(ii) Janel could be correct.**

**[1]**

---

---

**Please do not write in the margin.**

39. Asher took a tub of ice cream from the freezer and placed it on the table. He tried to scoop the frozen ice cream out using a metal spoon into a cup, but the ice cream was too hard.

(a) What could Asher do to the metal spoon so that he could scoop the ice cream out from the tub more easily? [1]

---

(b) Explain your answer in (a). [1]

---



---

After 10 minutes, he noticed that there were tiny water droplets formed on the outer surface of the ice cream tub.

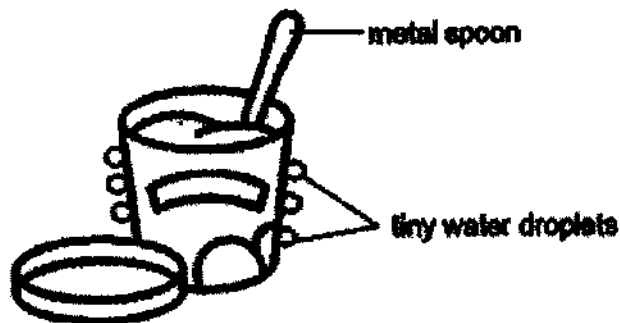

(c) Explain how the tiny water droplets were formed. [2]

---



---



---

Asher placed the ice cream tub back into the freezer. The next day, when he took the ice cream tub out from the freezer, he noticed that a thin layer of ice had formed on the outer surface of the tub.

(d) Suggest a way he can prevent the thin layer of ice from forming. [1]

---



---

**Please do not write in the margin.**

40. Gillian made fruit smoothie by putting pieces of cut fruits and milk in an electrical blender which cut the fruits further into very fine pieces and mixes them with the milk as shown below.

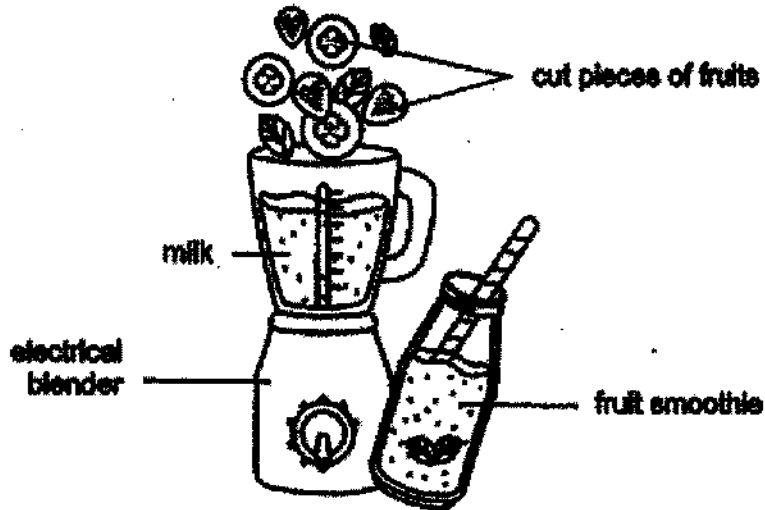

- (a) Fill in the boxes below with the correct forms of energy when Gillian switched on the blender. [1]

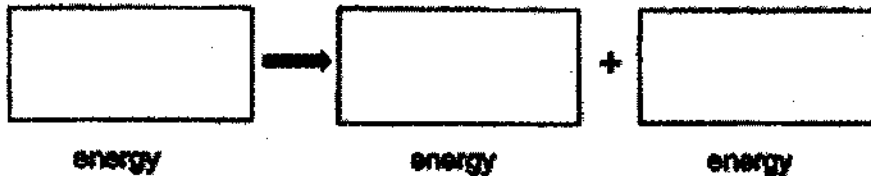

The diagram below shows a bicycle with a blender attached. Smoothies can be made by pedalling on the bicycle instead.

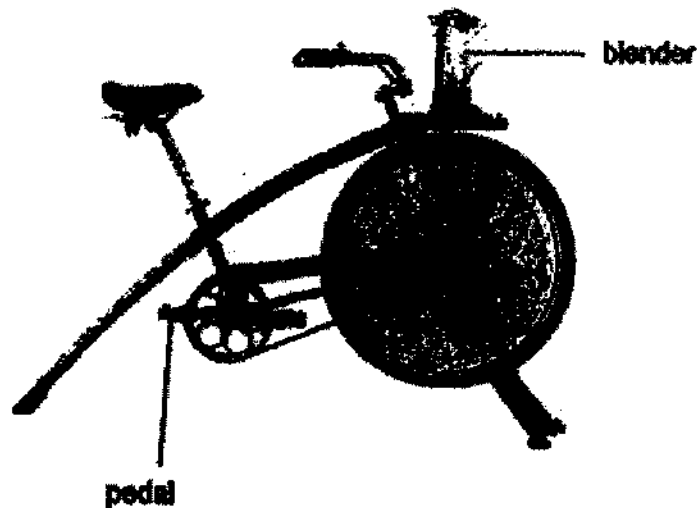

Question 40 continues on next page.

**Please do not write in the margin.**

**Question 40 continued**

The graph below shows the speed of pedalling and the level of smoothness of the smoothie mixture produced.

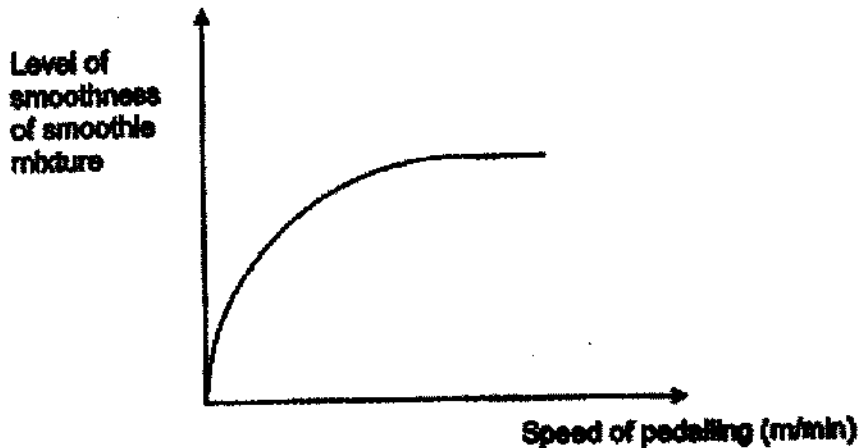

- (b) Based on the graph above, what is the relationship between the speed of pedalling and the level of smoothness of the smoothie mixture? [1]

---

---

- (c) State the source of energy for Gillian when she is pedalling the bicycle to make the smoothies. [1]

---

---

**Please do not write in the margin.**



41. Study the diagram below. When the button is pressed down, the metal lever will move.

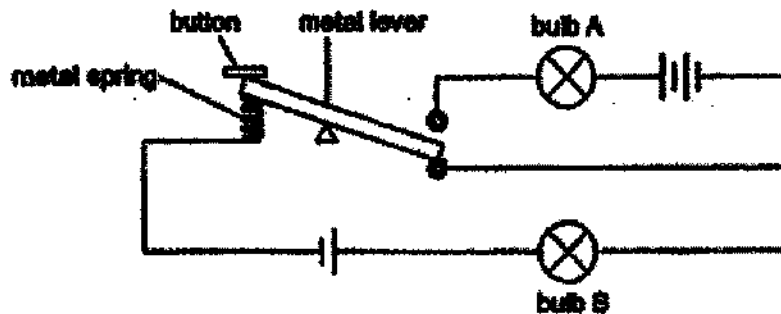

- (a) Which bulb(s) will light up when a person [1]  
 (i) presses the button? \_\_\_\_\_  
 (ii) releases the button? \_\_\_\_\_

- (b) Explain your answer in (a)(ii). [1]

---



---

- (c) Jayden replaced the metal spring with a stiffer metal spring.

Will he need to apply more, less or the same amount of force to switch [1]  
 on bulb A?

---



---

**END OF BOOKLET B**

**Please do not write in the margin.**



**SCHOOL : HENRY PARK PRIMARY SCHOOL**  
**LEVEL : PRIMARY 6**  
**SUBJECT : SCIENCE**  
**TERM : 2022 PRELIM**

---

**SECTION A**

1	2	1	3	1	3	3	4	2	2
2	3	2	4	3	1	3	3	3	3
2	2	1	2	3	3	4	4		

**Suggested answers for Science PRELIM 2022**

Qn	Suggested answer
29a	Part G: roots                      Part H: flowers
29b	It holds the plant upright.
30a	Pupa
30b	The number of fruits will decrease. The pesticide kills the caterpillars and there will be fewer butterflies to pollinate flowers.
31a	No. It has more than 6 legs.
31b	Living things respond to changes.
31c	To give animal Y time to move to its suitable condition.
31d	Its predators may not spot it easily in the dark.
32a	oxygen
32b	Set-up C. It has the most amount of light for the fastest rate of photosynthesis to take place.
32c	Place the light source closer to the hydrilla. / Add carbon dioxide into the water. / Add more hydrilla plants.
32d	Carry out the experiment in a dark room.
33a	It controls the population of bird X.
33b(i)	There will be less food for bird X
33b(ii)	There will be fewer places for bird X to lay eggs.
34a	Benefit for algae: The fungi provide water for the algae to make food. Benefit for fungi: They take in the food made by the algae.
34b	As the number of factories increases, the population of organism L decreases. The factories release pollutants that harm organism L.
35a	4 stages. Insects with a larval stage has 4 stages in their life cycle.
35b	It is protected from its predators.
36a	As the water fills the cup, it becomes heavier and moves down. As water flows out of the cup, it becomes lighter and moves up.

36b	The 'click' sound is heard more frequently. More water drips out and the cup fills up faster, so it moves down more frequently.
37a	The temperature will be higher. The air nearer the stones gains more heat from the stones.
37b	The air inside the refrigerator will gain less heat from the food, less electrical energy is needed to maintain the air at 10°C.
38a	Fan
38b	No. When S2 is switched on, electricity flows through the circuit and W becomes an electromagnet and attracts Q and the circuit for the fan is open.
38c(i)	The unlike poles are facing each other, the magnet and electromagnet attract each other and the circuit for the fan is open.
38c(ii)	The like poles are facing each other, the magnet and electromagnet repel and both circuits remain closed.
39a	Heat up the metal spoon.
39b	The ice cream gains heat from the spoon and melts.
39c	The water vapour in the surrounding air comes into contact with the cooler surface of the tub, loses heat quickly and condenses into tiny water droplets.
39d	Wipe off the water droplets before putting the tub back into the freezer.
40a	Electrical, Kinetic, Sound / Heat
40b	As the speed of pedalling increases, the level of smoothness increases until a certain point after which the speed of pedalling does not affect the level of smoothness.
40c	Food
41a	(i) A and B      (ii) B
41b	A closed circuit is formed with bulb B and it lights up but the circuit with bulb A is open.
41c	More

