



**NAN HUA PRIMARY SCHOOL
PRELIMINARY EXAMINATION 2022
PRIMARY 6**

SCIENCE

BOOKLET A

28 Multiple Choice Questions (56 marks)

Total Time for Booklets A and B: 1 hour 45 minutes

INSTRUCTIONS TO CANDIDATES

1. Write your name, index number and class in the spaces provided below.
2. Do not turn over the page until you are told to do so.
3. Follow all instructions carefully.
4. Answer all questions.
5. Use a 2B pencil to shade your answers on the Optical Answer Sheet (OAS).

Marks Obtained

Booklet A		/ 56
Booklet B		/ 44
Total		/ 100

Name: _____ () Class: P 6S _____

Date: 22nd August 2022

Parent's Signature: _____

This booklet consists of 23 printed pages.

Section A: (28 x 2 marks = 56 marks)

For each question from 1 to 28, four options are given. One of them is the correct answer. Make your choice (1, 2, 3 or 4). Shade the correct oval (1, 2, 3 or 4) on the Optical Answer Sheet.

1 Study the flow chart and diagrams below.

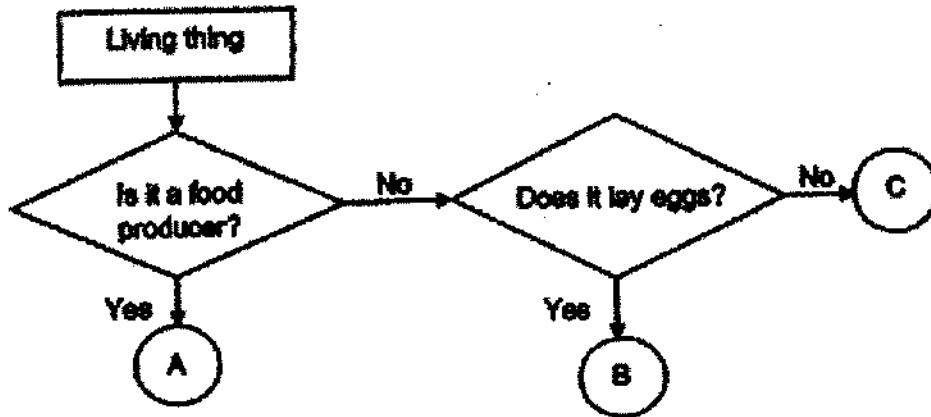

Living thing Y



Living thing Z



Which groups do living things, Y and Z, belong to?

	Living thing Y	Living thing Z
(1)	A	C
(2)	B	C
(3)	B	A
(4)	C	B

(Go on to the next page)

2 All observed organisms, W and X, and recorded his observations in the table below.

Observation	Organism	
	W	X
young resembles adult	No	No
4-stage life cycle	No	Yes
spends part of its life cycle in water	Yes	Yes

Which of the following correctly represents organisms, W and X?



	Organism W	Organism X
(1)	Frog	Mosquito
(2)	Frog	Cockroach
(3)	Chicken	Butterfly
(4)	Cockroach	Grasshopper

(Go on to the next page)

- 3 Amy filled four cups, A, B, C and D, with equal mass of soil. She placed three of the same type of seeds in each cup. The experimental conditions for each cup are shown in the table below.

Cup	Soil	Presence of light
A	Dry	No
B	Wet	No
C	Dry	Yes
D	Wet	Yes

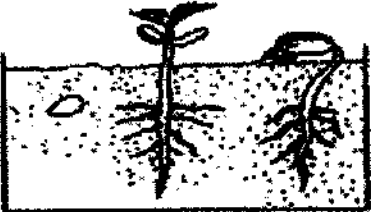
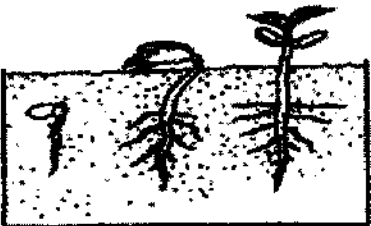
Which of the following did not show the correct possible appearance of the seeds in each cup on the 5th day?

	Cup	Appearance of seeds on 5 th day
(1)	A	
(2)	B	
(3)	C	
(4)	D	

4

Study the dispersal pattern of fruits of plant P.

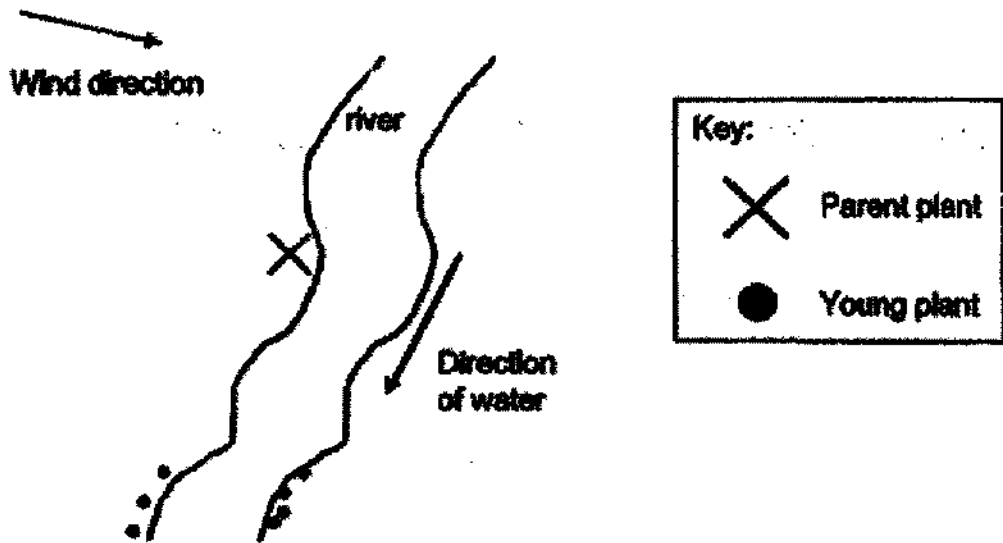

Which of the following is the most likely fruit from plant P?

(1)

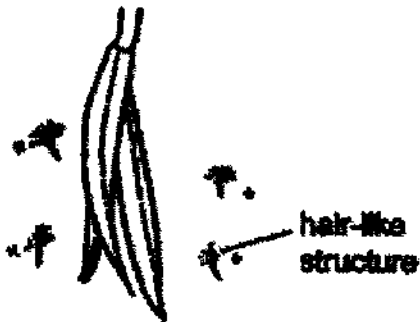

(2)

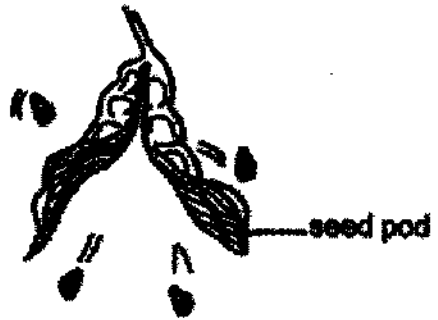

(3)

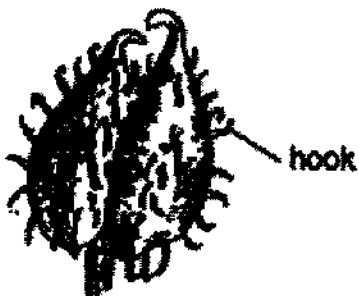

(4)

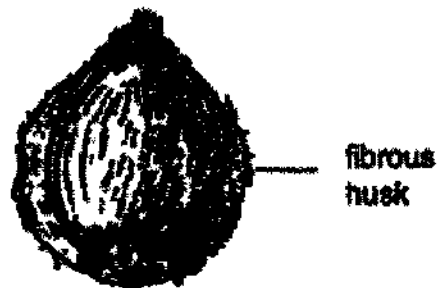

(Go on to the next page)

5 The diagrams below show the reproductive parts of a plant and a human respectively.

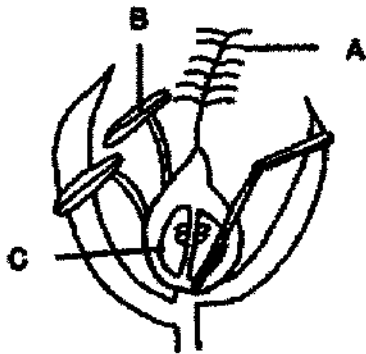

Plant

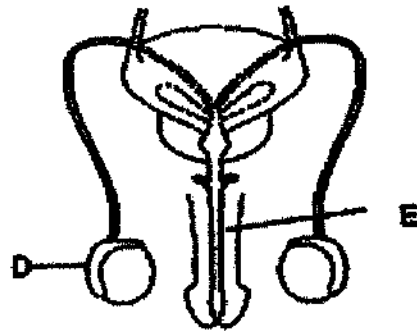

Human

Which of the following correctly identifies the parts that produce male reproductive cells?

	Plant	Human
(1)	A	D
(2)	B	D
(3)	B	E
(4)	C	E

6 James plucked three leaves, Q, R and S, of similar size from the same plant. These leaves have tiny openings known as stomata. Leaves lose water through these stomata.

He measured the mass of the leaves at the start of the experiment and coated the surfaces of the leaves with oil as shown in the table below.

Leaf	Coated with oil	
	Upper surface	Lower surface
Q	No	Yes
R	Yes	No
S	Yes	Yes

Then, he hung the leaves under the sun for an hour as shown below.

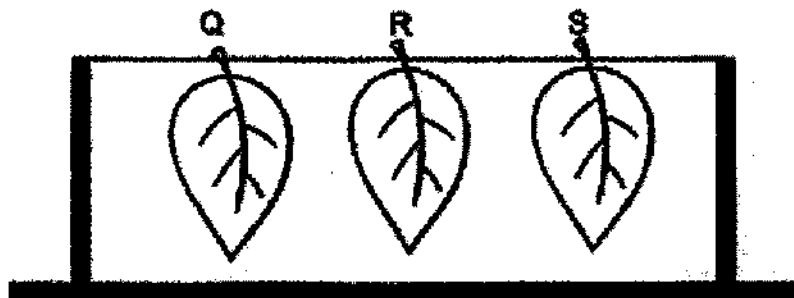

After one hour, he weighed the mass of the leaves again. He ranked the loss of mass of the leaves from the biggest to the smallest as shown in the table below.

biggest loss in mass	→	smallest loss in mass
leaf R	leaf Q	leaf S

Based on the experiment, which of the following could James conclude about the stomata on the leaves?

- (1) There are more stomata on the upper surface.
- (2) There are more stomata on the lower surface.
- (3) All the leaves perform gaseous exchange through their stomata.
- (4) There are equal number of stomata on the upper and lower surfaces of the leaves.

7 The diagram below shows how two different systems work together in the human body.

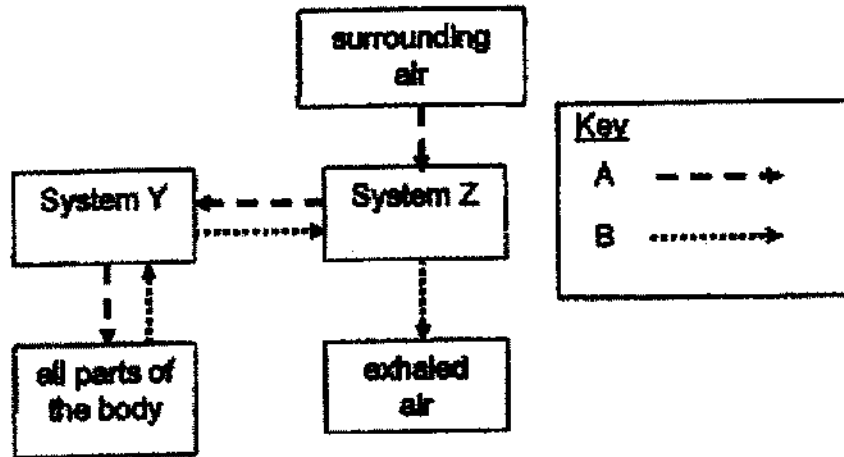

Which of the following correctly identifies systems Y and Z and substances A and B correctly?

	Substance A	Substance B	System Y	System Z
(1)	oxygen	carbon dioxide	respiratory	circulatory
(2)	carbon dioxide	oxygen	reproductive	circulatory
(3)	oxygen	carbon dioxide	circulatory	respiratory
(4)	water vapour	carbon dioxide	circulatory	reproductive

(Go on to the next page)

8 Which of the following diagrams shows how blood flows in the human body correctly?

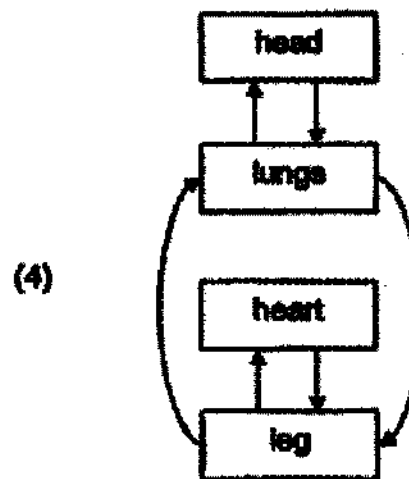
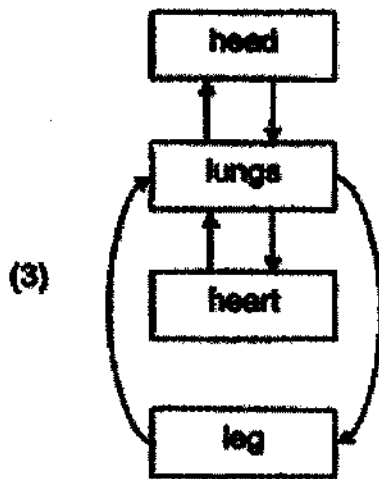
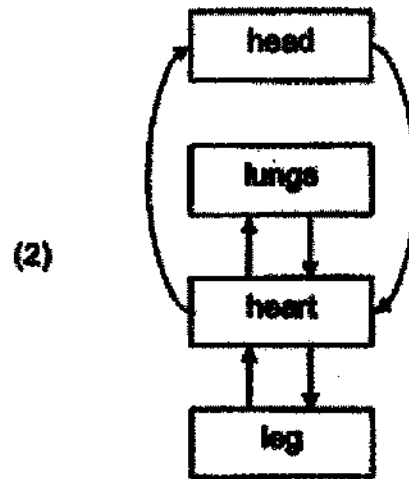
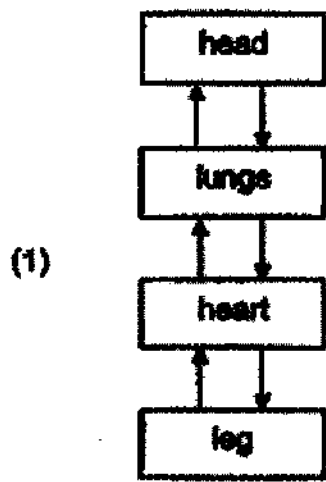

(Go on to the next page)

- 9 Faizal observed some cells under the microscope before and after placing them in a liquid containing substance Y. The diagrams below show his observation.

Before

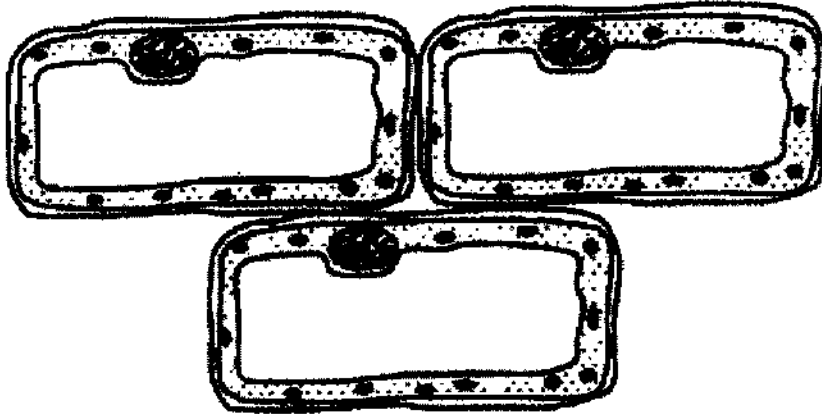

After

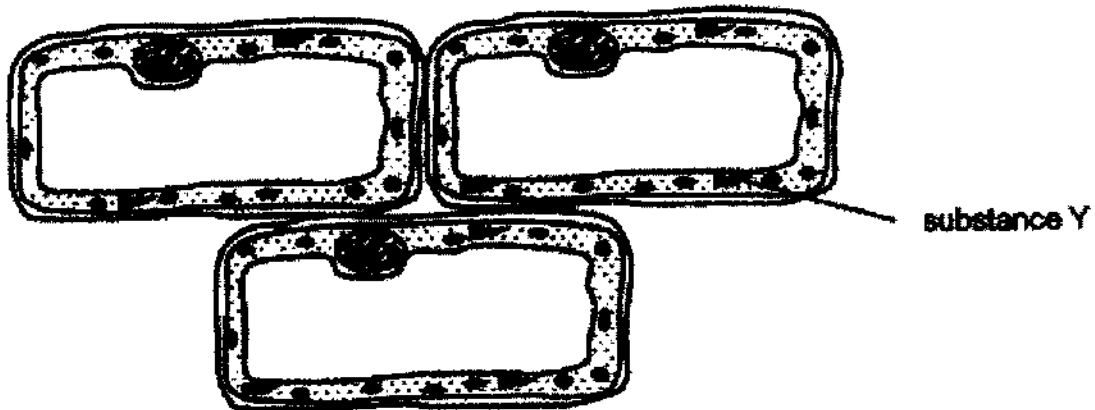

Which cell part(s) allow(s) for the movement of substance Y into the cell?

- A Nucleus
 - B Cell wall
 - C Cytoplasm
 - D Cell membrane
-
- (1) A only
 - (2) D only
 - (3) A and B only
 - (4) C and D only

(Go on to the next page)

- 10 The outer ring of the stem of a plant is removed as shown below. As a result, the water-carrying tubes and food-carrying tubes are removed at that section of the stem.

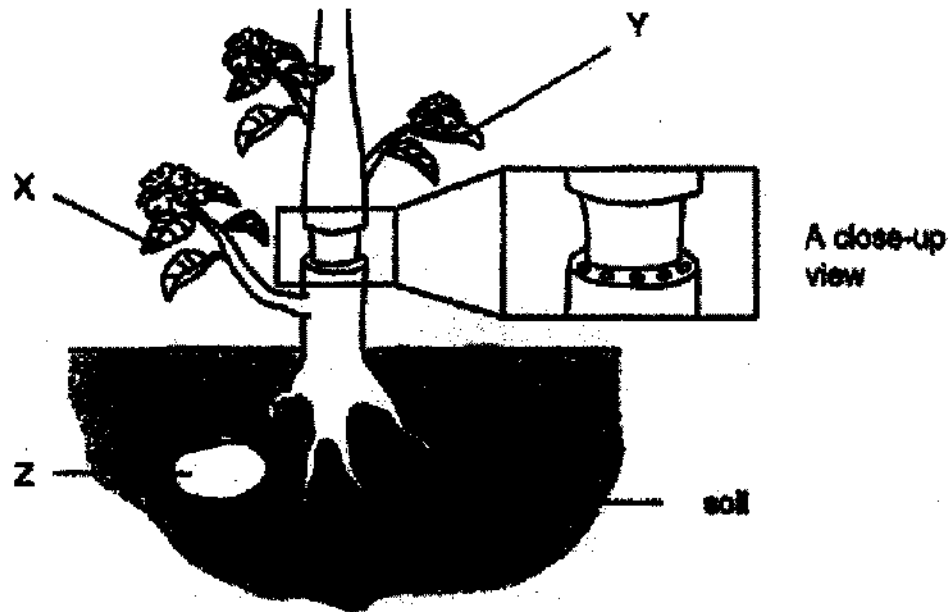

Which of the following correctly states the observation of part X, Y and Z after two months?

	Part X	Part Y	Part Z
(1)	wither	wither	becomes smaller
(2)	wither	remains green	becomes smaller
(3)	remains green	wither	becomes bigger
(4)	remains green	remains green	becomes bigger

(Go on to the next page)

11 The diagram below shows a habitat.

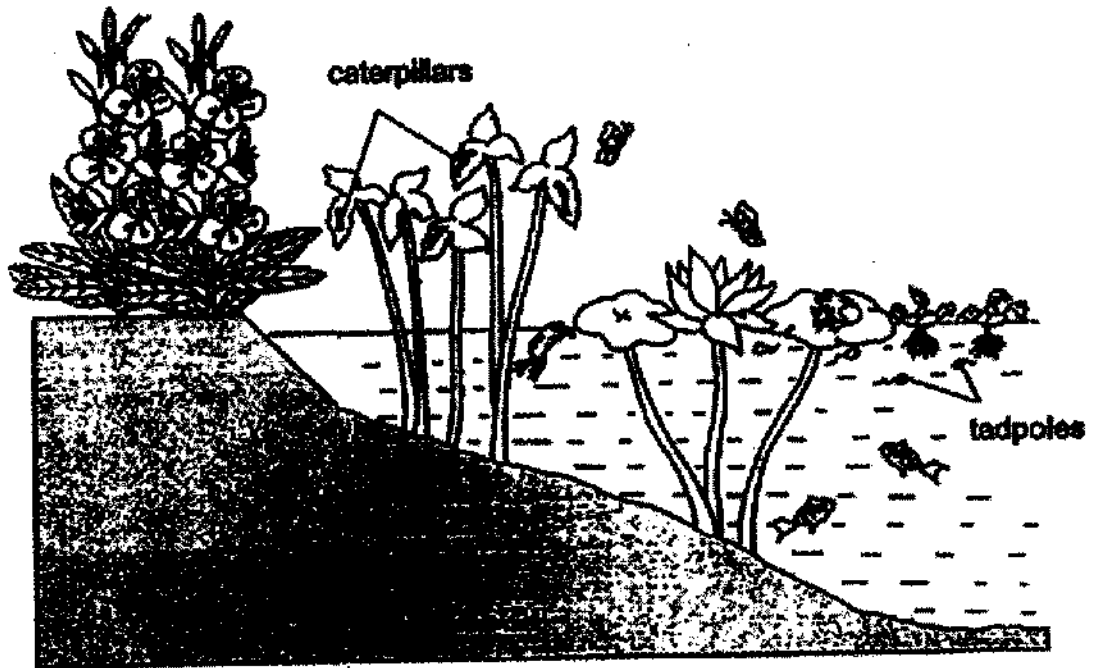

Which of the following correctly represents the habitat above?

	Number of populations of		Number of community
	plant	animal	
(1)	3	2	2
(2)	3	3	2
(3)	4	3	1
(4)	4	5	1

12 Study the food web of the different animals and plant as shown below.

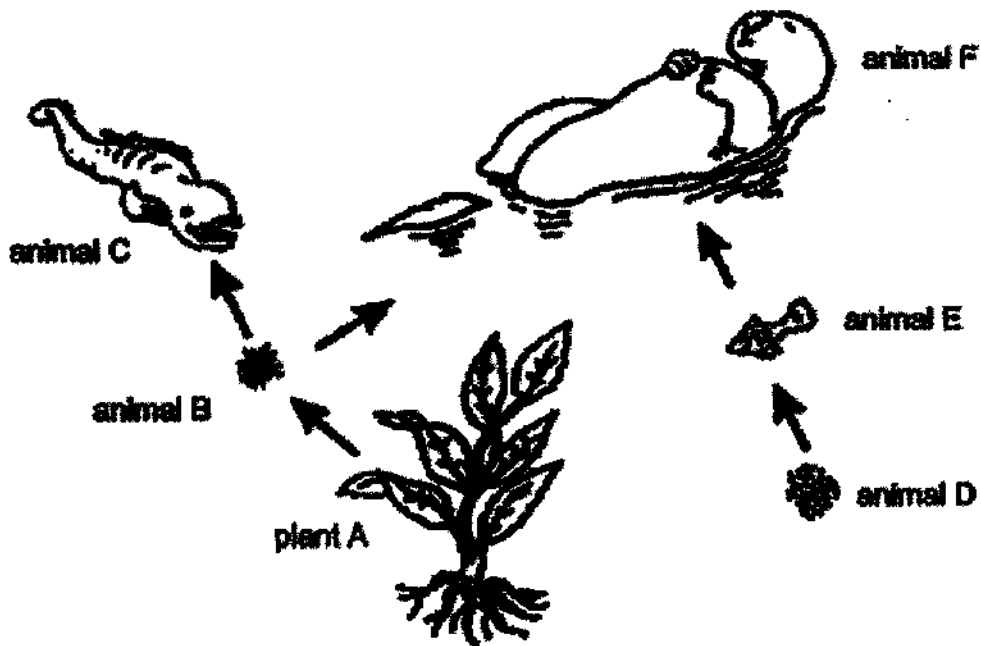

A large number of animal C were caught by fishermen.

Which of the following statement did not describe the change of the different populations correctly?

- (1) The population of plant A increased as the population of animal B increased.
- (2) The population of animal F increased as there were more animal B to feed on.
- (3) The population of animal D decreased as the population of animal E increased.
- (4) The population of animal B increased as the number of its predators decreased.

13 Some birds feed on the nectar of the flower as shown below.

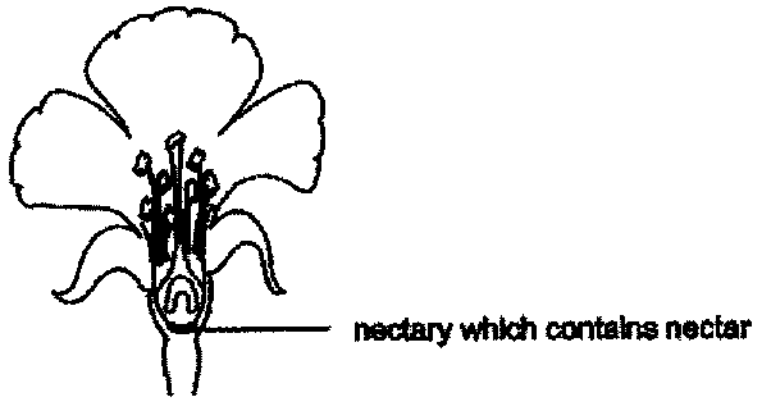

Which of the following birds feeds on the nectar of the flower above?

(1)



(2)



(3)



(4)



14 Which of the following can reduce the harmful effects of man's activities on the environment?

- A Plant more trees
- B Increase the use of air-conditioners
- C Use solar panel to generate electricity
- D Use public transport instead of driving a car

- (1) A and B only
- (2) C and D only
- (3) A, B and C only
- (4) A, C and D only

15 The diagram below shows 250 cm³ of water poured into each of the following apparatus.

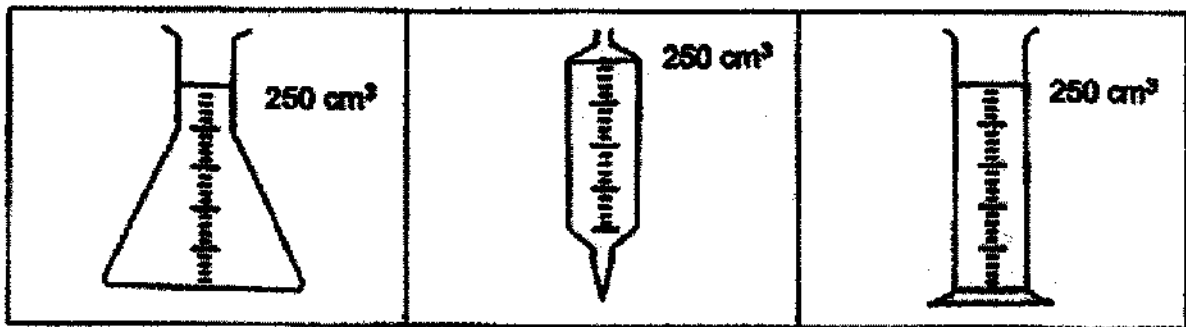

This experiment shows that a liquid _____.

- A can be compressed
- B has a definite volume
- C does not have a definite shape
- D takes the shape of its container

- (1) A and B only
- (2) C and D only
- (3) A and D only
- (4) A, C and D only

(Go on to the next page)

16 Which of the following correctly classifies the different processes?

	At a fixed temperature	Not at a fixed temperature
(1)	Melting	Boiling
(2)	Evaporating	Melting
(3)	Boiling	Freezing
(4)	Freezing	Evaporating

17 Water can exist in different states of matter when it gains or loses heat.

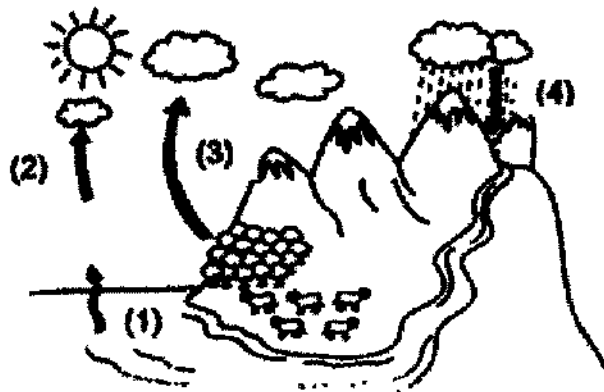

Which of the following correctly identifies the process and heat transfer of the arrows in the diagram above?

	Process	Heat transfer
(1)	Evaporation of water from the ocean into water vapour	Heat loss (from water)
(2)	Formation of clouds from water vapour	Heat gain (by water)
(3)	Loss of water through the stomata of plants	Heat gain (by water)
(4)	Rain or snow falling back to the Earth	Heat gain (by water)

- 18 Four different materials, A, B, C and D, are placed in a straight line as shown below. Material A has a round hole cut in its centre. A torch is placed in front of material A and light is shone through the hole.

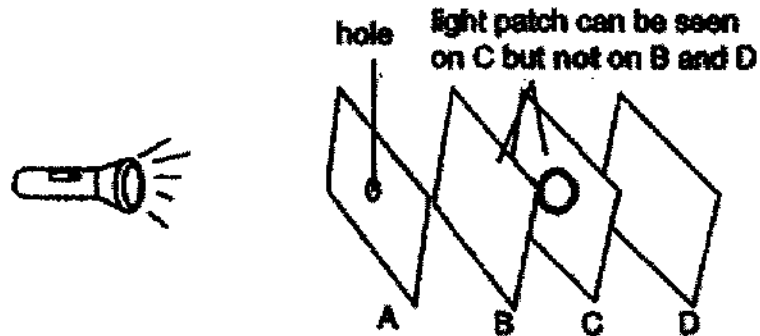

Which of the following is true about the materials shown above?

- (1) Material B is made of glass.
 - (2) Material A can only be a transparent material.
 - (3) Material C does not allow light to pass through it.
 - (4) Materials A, B and D allow light to pass through them.
- 19 Which of the following are true about light energy?
- A It makes things cold.
 - B It enables us to see objects.
 - C It comes mainly from the Sun.
 - D It is needed by plants during photosynthesis.
- (1) A and B only
 - (2) B and C only
 - (3) A, C and D only
 - (4) B, C and D only

(Go on to the next page)

- 20 Esther prepared three set-ups as shown below. Three identical plastic bottles, X, Y and Z, had an identical rubber balloon fitted over its mouth. Each bottle is placed in 3 similar basins containing 1 litre of ice or 1 litre of water at different temperatures.

The diagram below shows the balloons on the three bottles after five minutes.

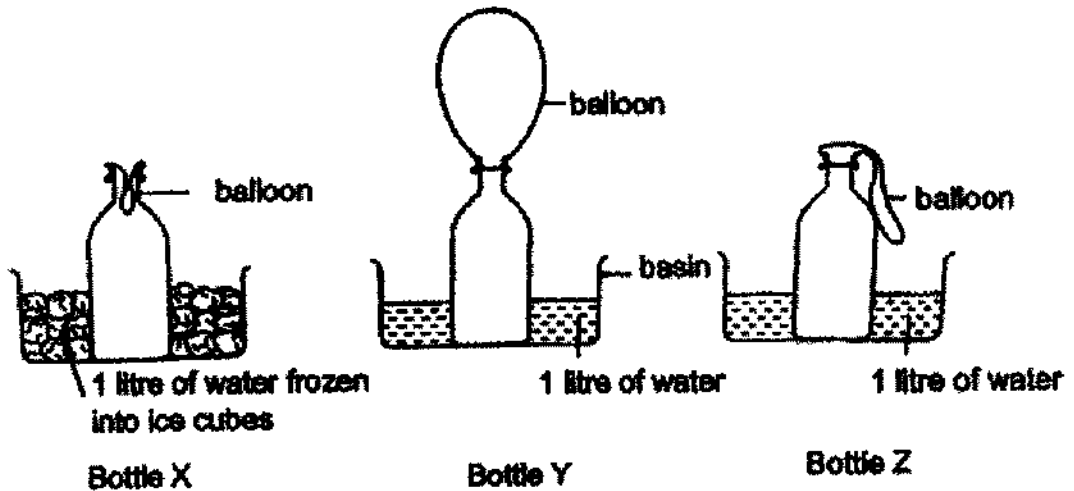

From the results of the experiment above, what can Esther conclude?

- A Air can be compressed.
 - B Elastic materials such as rubber stretch when heated.
 - C The temperature of the water in the basin containing bottle Y was the highest.
- (1) A only
(2) C only
(3) A, B and C
(4) A and C only

21 Jaime has a toy acrobat which can swing freely on a plastic rod.

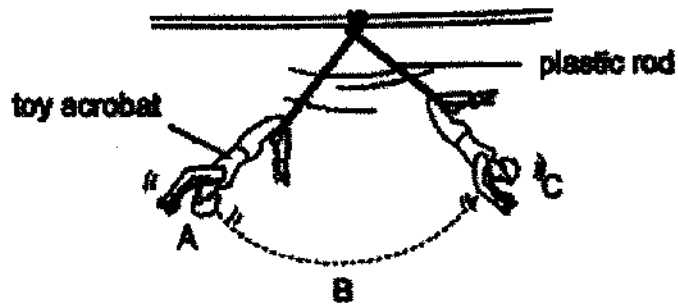

Which of the following graphs correctly shows how the amounts of gravitational potential energy and kinetic energy of the toy acrobat changed from point A to point C?

(1)

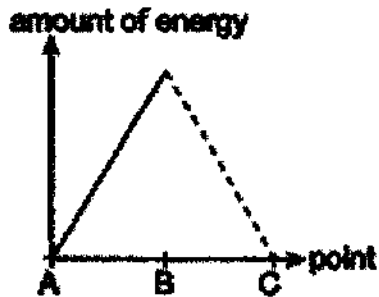

(2)

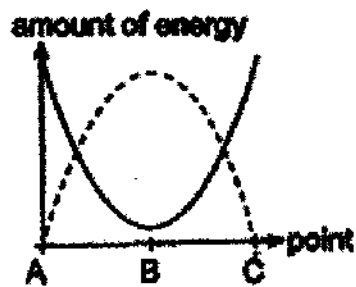

(3)

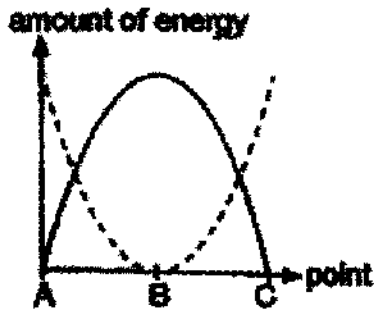

(4)

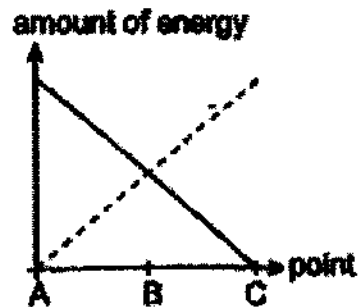

Key

— : gravitational potential energy
 - - - : kinetic energy

(Go on to the next page)

22 In which of the following circuit(s) would the bulb not light up?

(A)



(B)

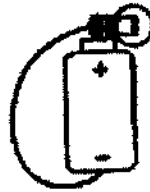

(C)



(D)



- (1) B only
- (2) C and D only
- (3) A and D only
- (4) B, C and D only

23 Study the circuit shown below.

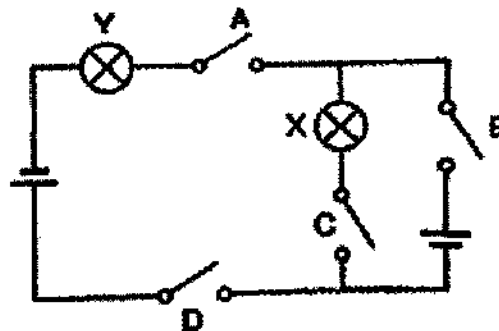

Which of the following correctly shows the switches that should be switched on and switched off so that only bulb X in the circuit above will light up?

	Switch A	Switch B	Switch C	Switch D
(1)	Off	On	On	Off
(2)	On	On	On	On
(3)	Off	Off	On	On
(4)	On	On	Off	Off

24 Alice found a material to fold into a boat. It floated on water for a while before sinking.

What are the properties of the material she used to fold the boat?

	Property	
	flexible	waterproof
(1)	no	yes
(2)	yes	no
(3)	no	no
(4)	yes	yes

25 Justin used a compass to locate the direction of the North and observed the needle pointing in the direction shown below.

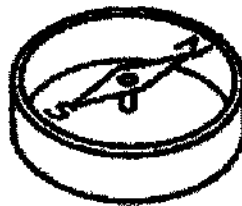

He then taped a magnet to a strip of styrofoam and placed it in a basin of water to float freely.

Which of the following diagrams represents the final resting position of the styrofoam strip?

(1) magnet taped to a strip of styrofoam

(2) magnet taped to a strip of styrofoam

(3) magnet taped to a strip of styrofoam

(4) magnet taped to a strip of styrofoam

(Go on to the next page)

26 Which of the following statements about magnetic force are true?

- A Magnetic force can act at a distance.
- B Magnetic force allows a magnet to attract a piece of iron.
- C Magnetic force is the strongest at both poles of a magnet.

- (1) A only
- (2) C only
- (3) A and B only
- (4) A, B and C

27 Study the diagram below carefully.

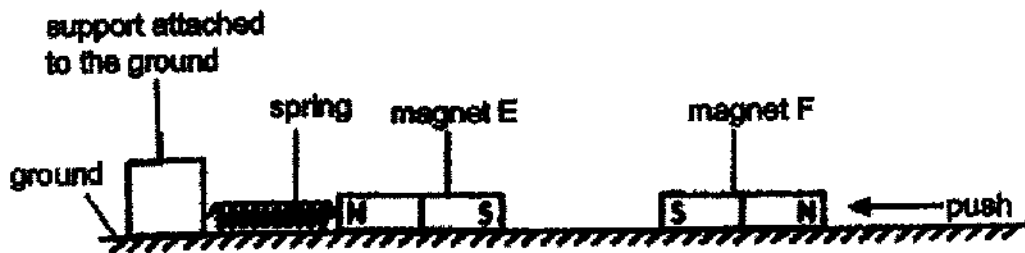

Which of the following forces are acting on magnet E as magnet F is moved towards it?

- A Friction
- B Gravity
- C Magnetic force
- D Elastic spring force

- (1) A and D only
- (2) C and D only
- (3) A, B and C only
- (4) A, B, C and D

(Go on to the next page)

28 The diagram below shows the length of a spring when different masses were hung on it.

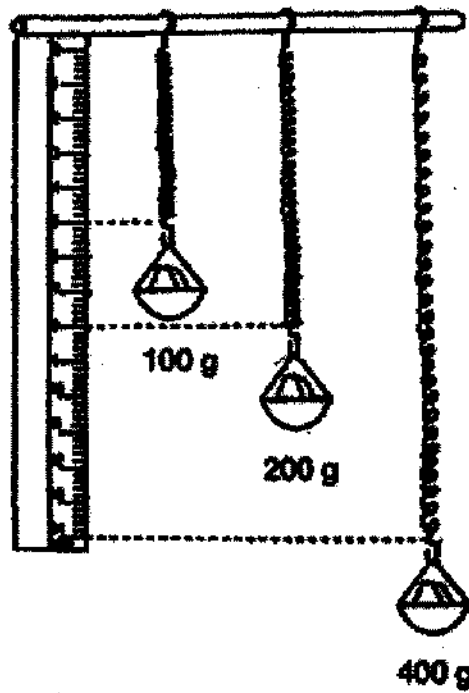

What is the original length of the spring?

- (1) 1 cm
- (2) 2 cm
- (3) 3 cm
- (4) 4 cm



**NAN HUA PRIMARY SCHOOL
PRELIMINARY EXAMINATION 2022
PRIMARY 6**

SCIENCE

BOOKLET B

13 Open-ended questions (44 marks)

Total Time for Booklets A and B: 1 hour 45 minutes

INSTRUCTIONS TO CANDIDATES

1. Write your name, index number and class in the spaces provided below.
2. Do not turn over the page until you are told to do so.
3. Follow all instructions carefully.
4. Answer all questions.
5. Use a dark blue or black ballpoint pen to write your answers in the space provided for each question.
6. Do not use correction fluid/tape or highlighters.

Marks Obtained

Section B

	144
--	-----

Name: _____ () **Class: P 6S** _____

Date: 22nd August 2022

Parent's Signature: _____

This booklet consists of 16 printed pages.

Section B: (44 marks)

For questions 29 to 41, write your answers in the spaces provided.

The number of marks available is shown in brackets [] at the end of each question or part question.

29 The diagram below shows how a fruit is formed from the flower of plant P.

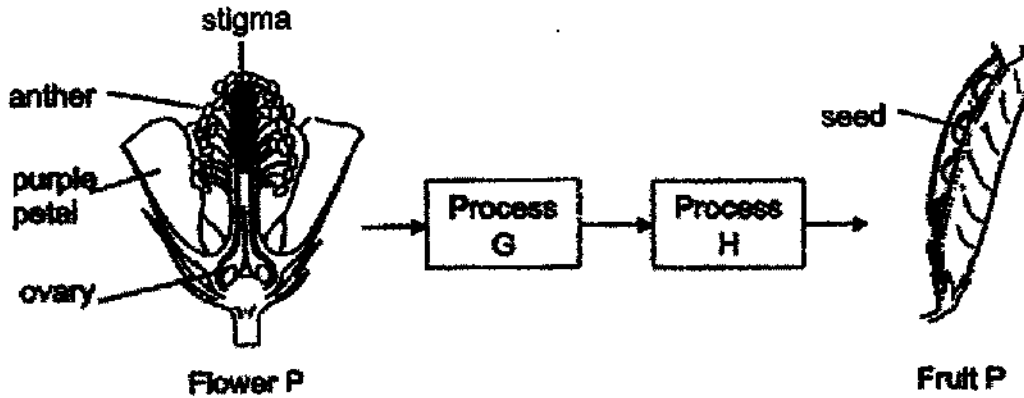

(a) Name processes G and H. [1]

(i) Process G: _____

(ii) Process H: _____

(b) Describe process G. [1]

(c) The flower of P as shown in the diagram above is purple in colour. Joseph grows plant P in his windy garden. He notices that plant P has flowers but bears no fruit. Explain why the flowers of his plant P bear no fruit. [1]

(d) Joseph thinks that keeping bees in his garden may help plant P bear fruit. Do you agree with him? Explain your answer. [1]

(Go on to the next page)

Score	
	4

30 The diagram below shows the digestive system of a human.

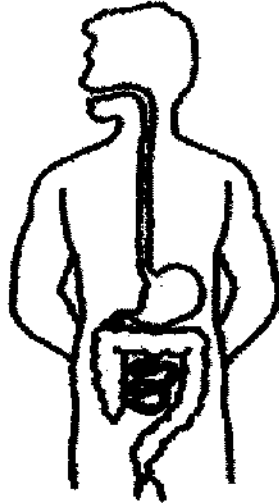

- (a) Identify and label the part of the digestive system where food is completely digested and absorbed in the above diagram. [1]
- (b) Describe how the different human systems help oxygen and digested food to reach the legs to generate energy for you to run. [2]

Respiratory system: _____

Circulatory system: _____

(Go on to the next page)

Score	3
-------	---

31 The diagram below shows the structure of a single-celled organism A.

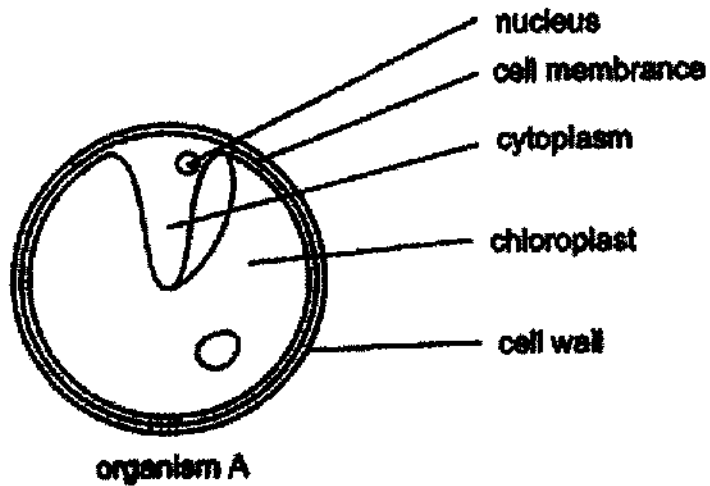

(a) Can organism A make food? Explain your answer. [1]

(b) Organism A is found in water. How do other animals in the water benefit from organism A? [1]

(c) What role does organism A play in a food chain? [1]

(Go on to the next page)

Score	3
-------	---

32 Peter sets up the experiment as shown below.

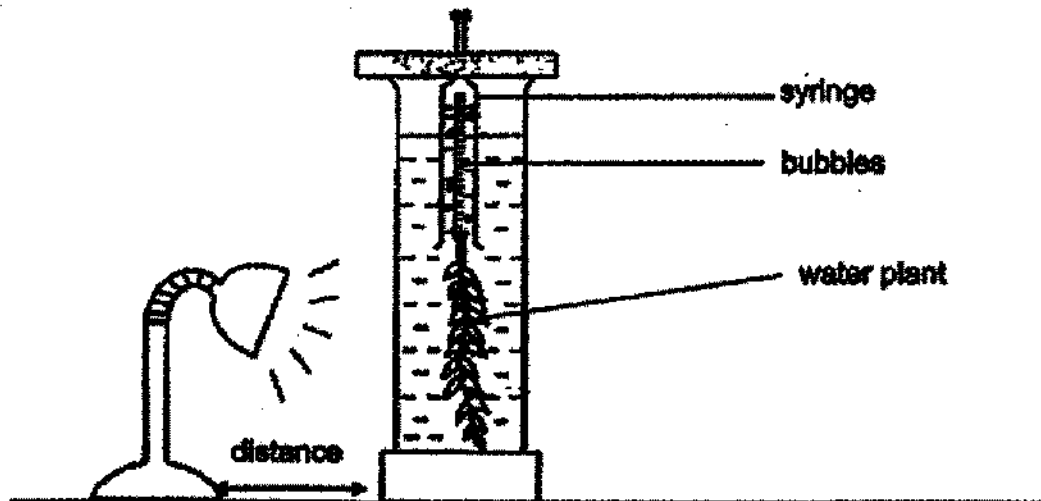

He measures the volume of gases collected in the syringe at various positions of the lamp and records the results as shown below.

Distance between the lamp and the set-up (cm)	10	20	30	40
Volume of gas (unit)	16	12	8	4

(a) What is the gas that is measured in the syringe? [1]

(b) Tick the variable(s) that need(s) to be kept constant in this experiment. [1]

<input type="checkbox"/>	Colour of light
<input type="checkbox"/>	Temperature of the water
<input type="checkbox"/>	Distance between the lamp and the plant

(c) Based on results in the table above how does the amount of light affect the rate of photosynthesis? [1]

(Go on to the next page)

Score	3
-------	---

33 The life cycle of organism B is shown in the diagram below.

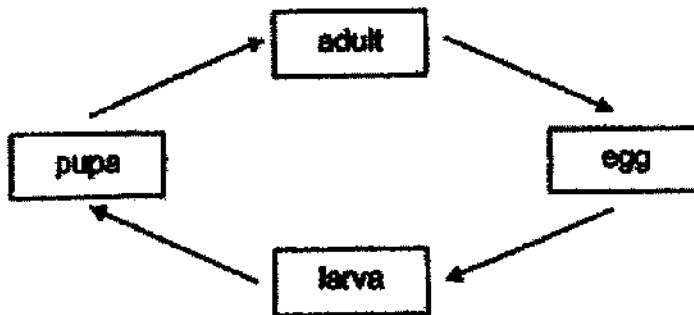

A group of researchers kept some organism B at different surrounding temperatures and observed the days needed for organism B to develop in each stage of its life cycle. The results are shown in the table below.

	Number of days needed of each stage at different surrounding temperature			
	22 °C	26 °C	30 °C	34 °C
Egg	13	8	6	2
Larva	4	4	4	4
Pupa	6	6	6	6
Adult	7	10	12	15

(a) Organism B spreads disease X to human when it is in the adult stage.

Based on the results of the experiment, what might happen to the number of cases of disease X in the future as global warming continues? Explain your answer. [2]

(b) The diagram below shows a food chain involving the different organisms in a village.

Plant A → Organism B → Organism C → Organism D

Some villagers remove organism D from the village. Explain how this affects the population of organism B. [1]

(Go on to the next page)

Score	3
-------	---

- 34 A container filled with dry soil was divided into 4 equal areas, A, B, C and D, as shown in the diagram below. Equal amount of water was sprinkled onto both areas C and D. A thick black cloth was used to cover areas B and C.

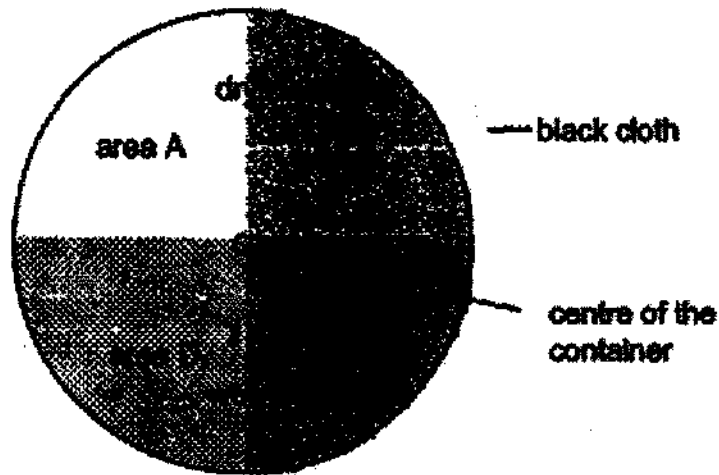

Paul placed twenty organism S in the centre of the container at the beginning of the experiment.

After an hour, the total number of organism S in each area was counted and recorded in the bar chart below.

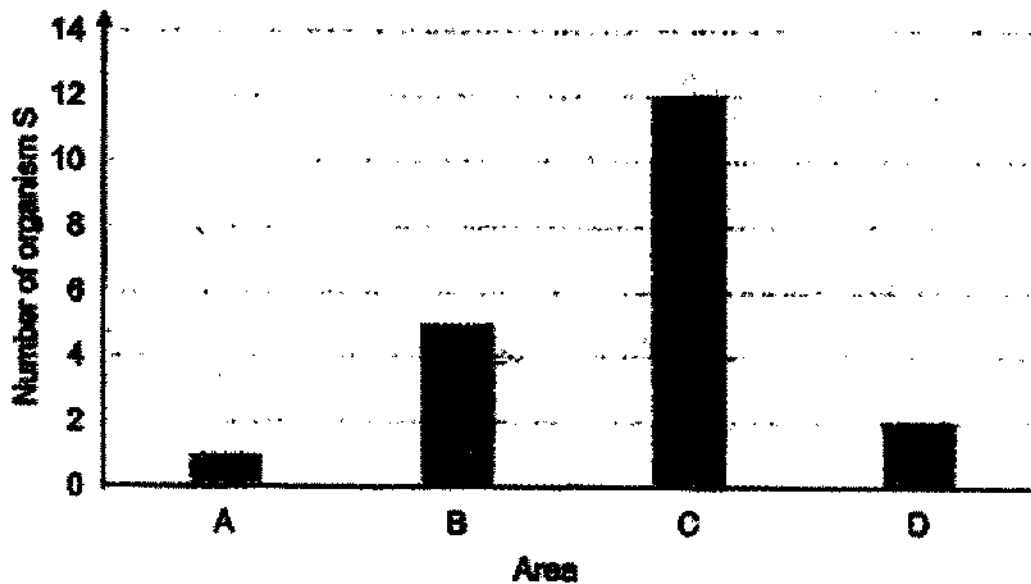

(Go on to the next page)

- (a) (i) Tick the type of habitat organism S was most likely found in. [2]

	Pond
	Desert
	Garden
	Leaf litter

- (ii) Explain your answer to (a)(i).

- (b) Paul counted the number of organism S in each area 30 minutes after the start of the experiment.

Why did he not count the number of organism S immediately after starting the experiment? [1]

- (c) Paul wanted to investigate how different substances, F, G and H were effective in keeping organism S away.

Using all the materials, substances, F, G and H, wet soil, black cloth and same container as the original experiment, describe how he can conduct an experiment to carry out his investigation. You may use the diagram below in your answer. [2]

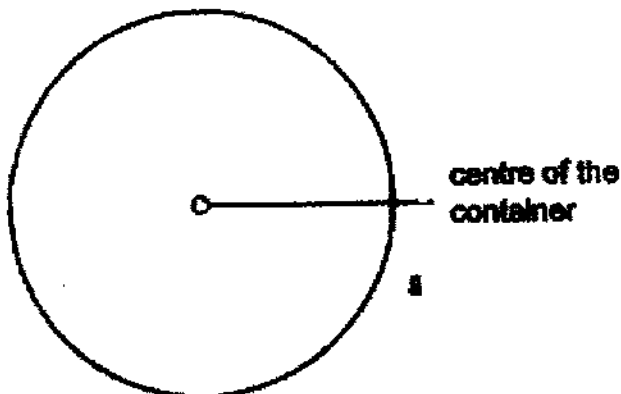

(Go on to the next page)

Score	5
-------	---

- 35 The common household lizard as shown below has a tail which can be dropped and regrown.

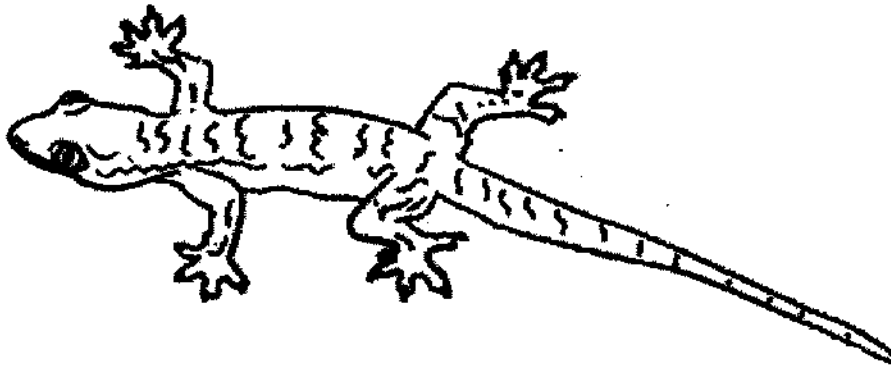

- (a) Explain why the lizard's ability to drop its tail can be an advantage when it is attacked by its predator. [1]

- (b) The lizard's toes are expanded into pads that allow it to stick to vertical surfaces such as walls.

Explain how the lizard's ability to climb walls of buildings can be an advantage when it is searching for insects it feeds on. [1]

- (c) Researchers have discovered that lizard eggs that incubate at a temperature of 32 °C and above will hatch into female offsprings.

The average monthly maximum temperature in Singapore in May 2022 was 32.9 °C. How will the population of the lizard in Singapore be affected if this trend persists? Explain your answer. [2]

(Go on to the next page)

Score	
	4

36 Study the diagrams shown below.

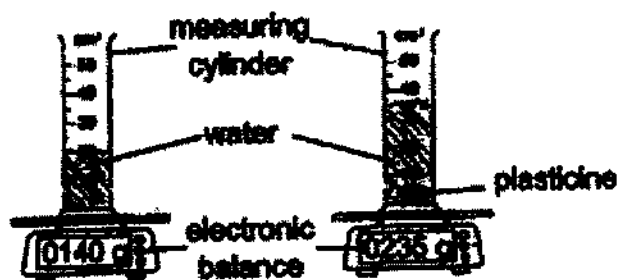

(a) What is the mass of the plasticine? [1]

(b) What is the volume of the plasticine? [1]

(Go on to the next page)

Score	/
	2

37 Fred constructed the following set-up according to the steps given in the box below.

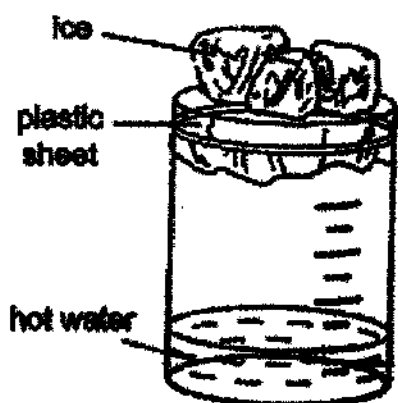

Step 1:
Pour hot water into a glass container.

Step 2:
Cover the mouth of the glass container with a plastic sheet and fastened it tightly with a rubber band.

Step 3:
Place some ice cubes on the plastic sheet

After a few minutes, Fred observed that there were droplets of water formed.

(a) Based on the set-up above, state where the droplets of water would be found. [1]

(b) Explain your answer in (a). [2]

The diagram below represents the different parts of the water cycle.

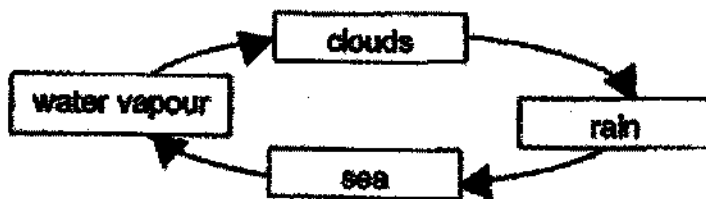

(c) Which part of the water cycle does water droplets in (a) represent? [1]

(Go on to the next page)

Score	4
-------	---

38 The diagram below shows the set-up of an experiment.

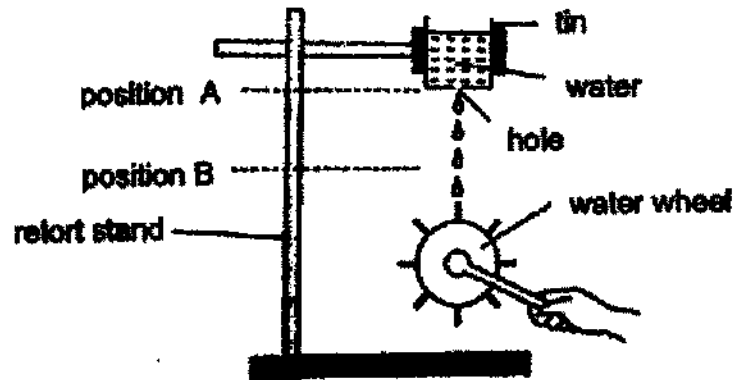

(a) Fill in the boxes below to show the type of energy changes in the experiment above. [1]

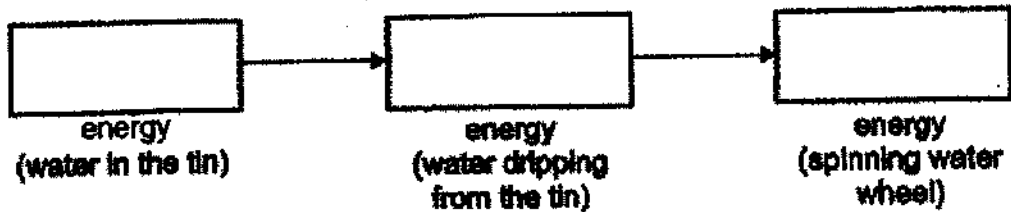

(b) If the tin is lowered from position A to position B, how will this affect the movement of the water wheel? Explain your answer in terms of energy. [2]

(c) Without shifting the position of the tin and the water wheel in the set-up, what can be done to increase the speed of the movement of the water wheel? [1]

(Go on to the next page)

Score	4
-------	---

- 30 Material Q is a conductor of electricity. Mindy designed an experiment as shown below.

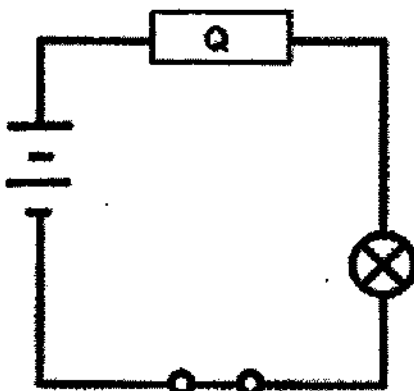

She recorded the results in the table below.

Length of material Q (cm)	Brightness of the bulb (units)
5	3
10	2
15	1

- (a) What is the relationship between the length of material Q and the level of brightness of the bulb? [1]

- (b) Other than keeping the length of material Q and number of bulbs the same, list one other constant variable for this experiment. [1]

(Go on to the next page)

Score	
-------	--

- 40 A group of students wanted to find out which material is the poorest conductor of heat. They set up an experiment and placed each material against a window (facing the thermometer inside of a warm room) on a cold day as shown below.

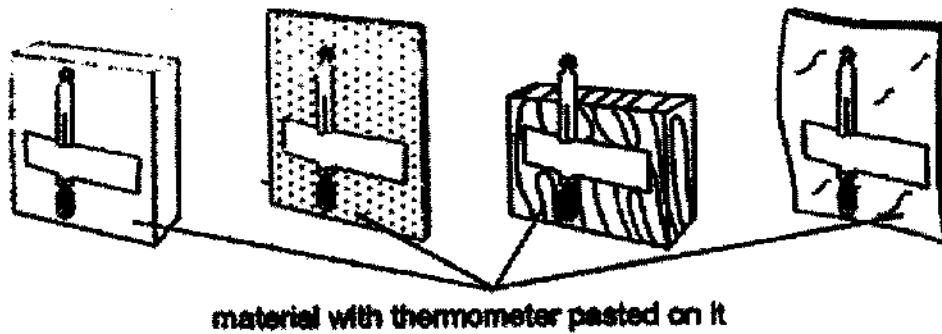
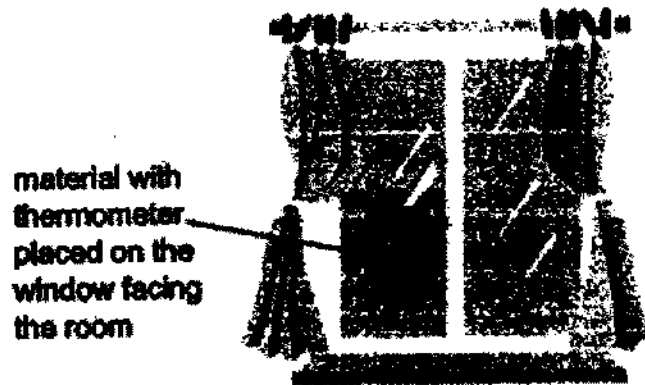

- (a) State one reason why the above experiment was not a fair test. [1]

- (b) If the experimental set-ups were corrected and the test was made fair, how could the students tell which material was the poorest conductor of heat? [1]

(Go on to the next page)

Score	2
-------	---

41 Manson sets up the experiment as shown below.

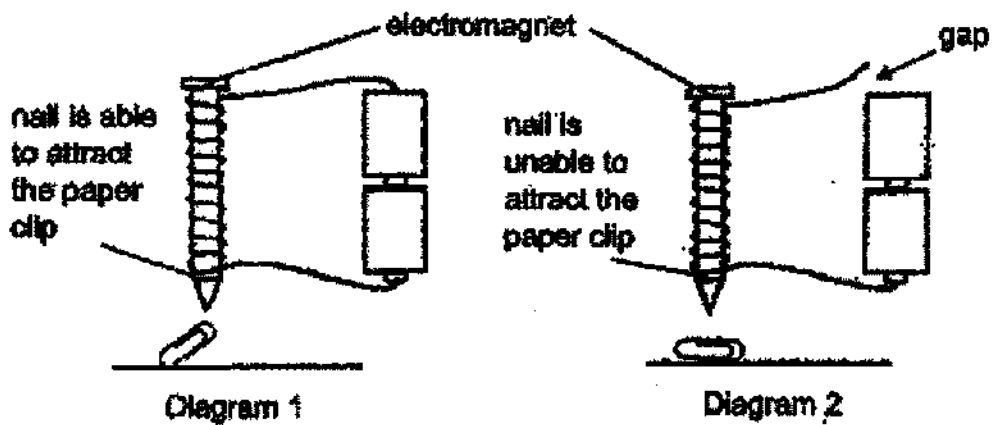

(a) Based on diagram 1, state the force present between the nail and the paper clip? [1]

Diagram 3 below shows how the crane uses the electromagnet to collect the scrap metals from the rubbish in the bin.

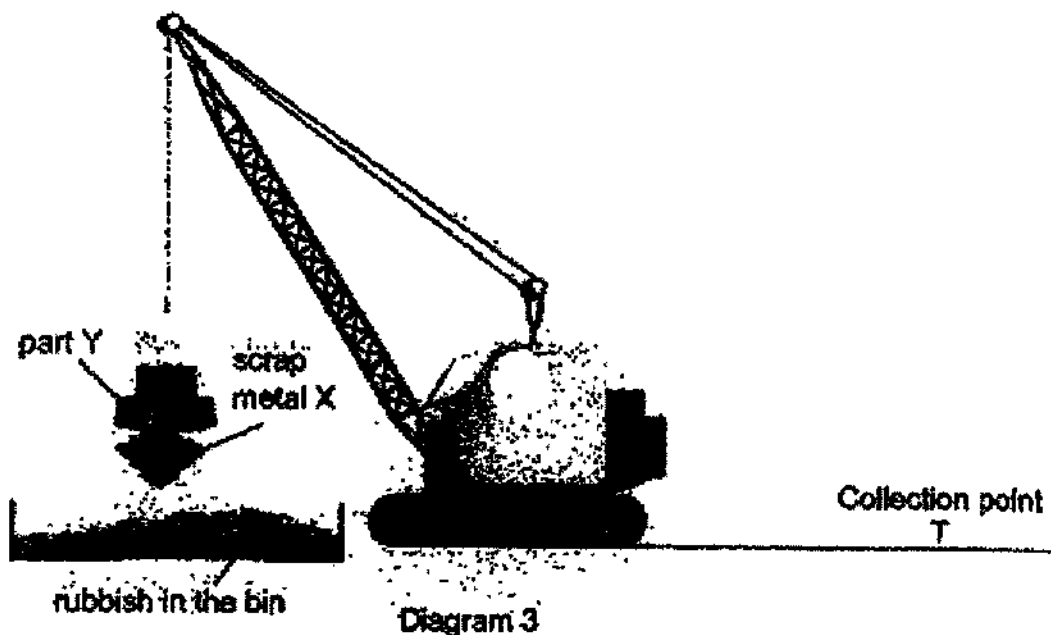

(Go on to the next page)

(b) Name 2 types of metals that scrap metal X can be made of. [1]

(c) Based on diagrams 1 and 2, explain how the electromagnet in the crane works to move the scrap metal X from the bin to collection point T in diagram 3. [2]

(d) Can the crane continue to work when the electromagnet is replaced with a permanent magnet? Explain your answer. [1]

Score	
-------	---

~ End of Paper ~

SCHOOL : NAN HUA PRIMARY SCHOOL
LEVEL : PRIMARY 6
SUBJECT : SCIENCE
TERM : 2022 PRELIM

SECTION A

3	1	3	4	2	2	3	2	2	3
3	1	2	4	2	4	3	3	4	4
2	2	1	2	3	4	4	2		

Nan Hua Primary School
2022 Prelims Answer Key

Qns	Answer
29(a)(i)	Process G: pollination
29(a)(ii)	Process H: fertilization
29 (b)	The transfer of pollen grain from the anther to the stigma of the flower.
29(c)	Flower of plant P are brightly coloured so as to attract the bees / animals / insects. / Flower of plant P does not have hairy stigma. Therefore, flower of plant P is pollinated by animal / insect / pollinator and not by wind.
29(d)	C- Yes. E- Plant P has insect pollinated flower. C- Flowers will be pollinated by the bees and fertilized. L- Flowers will develop into fruits.
30(a)	Small intestine
30(b)	Respiratory System: Air enters the nose to the lung. Oxygen (In the air) is absorbed into the bloodstream in the lungs/alveoli.
	Circulatory System: The heart (in the circulatory system) pumps the blood with digested food and oxygen through the blood vessel to the legs to generate energy.
31(a)	Yes. Organism A has chloroplast that can trap sunlight to make food.
31(b)	Other animals in the water obtain oxygen/food from organism A.
31(c)	It is a food producer.
32(a)	Oxygen
32(b)	/ Colour of light / Temperature of the water
32(c)	The greater the amount of light, the greater the rate of photosynthesis.
33(a)	First point: [1] - Number of cases of disease X will increase. 2nd point: [1/2] B can survive / stays as adults for a greater number of days / B takes a shorter time to develop from an egg to an adult 3rd point: [1/2] More adult B to spread disease X to human
33(b)	There is less/no organism D/ predators to prey on organism C. The population of organism C will increase. More C will feed on organism B and population of organism B decreases.
34(a)(i)	/ Leaf litter

34(a)(ii)	Evidence - The greatest number of organism S is found in area C Reason - Organism S prefers dark/shady and damp/wet environment which is the conditions of the leaf litter.
34(b)	To allow organism S time to go to the area that they prefer.
34(c)(i)	Fill the (whole) container with wet soil. Divide into 3/4 equal areas and place different substances F, G and H in each area. Release 20 organisms S at the centre of the container. Cover the whole container with dark cloth and count the number of organism S in each area after 30 minutes.
35(a)	When the lizard drops its tail, it can distract its predator and help it escapes.
35(b)	It can reach more / higher / high areas to look for more insect / food / higher chance of getting food / look for food easily
35(c)	Population of lizard will decrease. There are less / no male lizards to fertilise lizard eggs.
36a	95 g
36b	15 cm ³
37a	The droplets of water would be found on the underside of the plastic sheet in the glass container.
37b	The hot water in the glass container will evaporate to form water vapour. The water vapour will come into contact with the cooler underside of the plastic sheet, lose heat to it and condense to form water droplets.
37c	Clouds
38a	(Gravitational) potential energy -> Kinetic energy -> Kinetic energy
38b	The wheel will spin slower. The amount of gravitational potential energy will be decreased when the tin is lowered from position A to position B. Less gravitational potential energy will be converted to less kinetic energy of the water dripping from the tin which will then be transferred to less kinetic energy of the spinning wheel.
38c	Increase the size of the hole on the tin.
39a	As the length of material Q increases, the level of brightness of the bulb decreases.
39b	The number of batteries in the circuit. The type of bulb / battery / voltage of batteries / thickness of wire / width of material Q
40a	The thickness / size of the material is different.
40b	The thermometer attached to the poorest conductor of heat will have the highest temperature reading.
41a	Magnetic force of attraction.
41b	Iron / steel / nickel / cobalt

41c	When the circuit is closed, the electric current can flow through the circuit and part Y of the crane will become an electromagnet and is able to attract the scrap metal X/magnetic scrap metal. The crane will turn to collection point T and when the electricity is cut off when the switch is turned off, no electric current can flow through the circuit and part Y is no longer an electromagnet. Hence the scrap metal X/magnetic scrap metal will fall off from part Y.
41d	No. If the electromagnet is replaced by the magnet, the scrap metal X will continue to be attracted to the magnet and cannot perform the function of releasing/dropping the scrap metal X at collection point T.