



2022 PRIMARY 6 PRELIMINARY EXAMINATION

Name: _____ ()

Date: 23 August 2022

Class: Primary 6 ()

Time: 8.00 a.m. – 9.45 a.m.

Duration: 1 hour 45 minutes

SCIENCE BOOKLET A

INSTRUCTIONS TO CANDIDATES

1. Write your name, class and register number.
2. Do not turn over this page until you are told to do so.
3. Follow all instructions carefully.
4. Answer all questions.
5. Shade your answers on the Optical Answer Sheet (OAS) provided.

Booklet A (28 x 2 marks)

For each question from 1 to 28, four options are given. One of them is the correct answer. Make your choice (1, 2, 3 or 4) and shade your answer on the Optical Answer Sheet. (56 marks)

1. The table below shows the characteristics of 4 things.

Thing	Can it produce its own food?	Can it reproduce?	Can It move freely from place to place?	Key ✓ : Yes x : No
A	x	x	✓	
B	✓	✓	x	
C	x	x	x	
D	x	✓	✓	

Based on the table above, which of the things can be classified as a living thing?

- (1) B only
- (2) A and D only
- (3) B and D only
- (4) A, B, C and D

2. Three cells, A, B and C, are shown below.

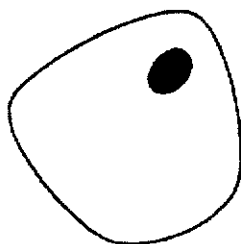

cell A

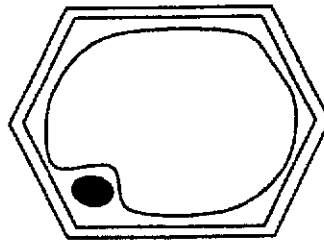

cell B

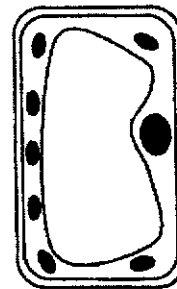

cell C

Where are cells, A, B and C, likely to be taken from?

- | | | | |
|-----|---------------|---------------|---------------|
| | cell A | cell B | cell C |
| (1) | cheek | leaf | root |
| (2) | root | leaf | cheek |
| (3) | cheek | root | leaf |
| (4) | root | cheek | leaf |

3. Study the diagram below.

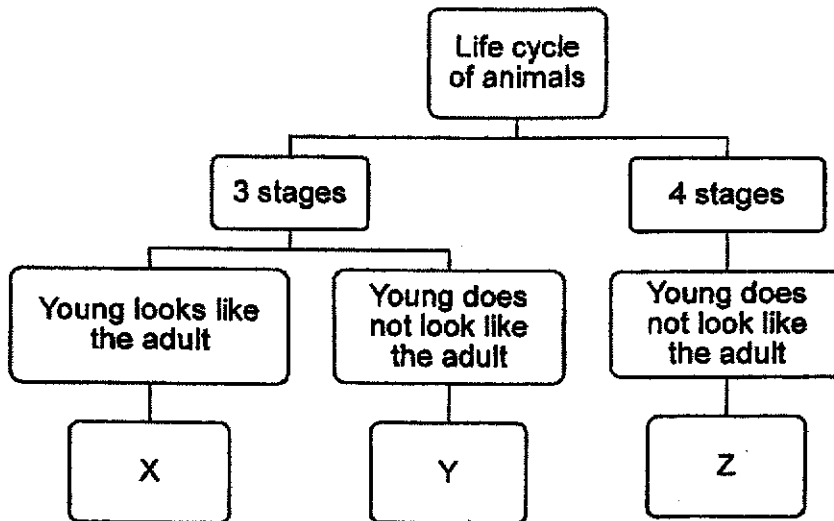

Which of the following represents X, Y and Z?

	X	Y	Z
(1)	beetle	frog	butterfly
(2)	grasshopper	frog	butterfly
(3)	butterfly	grasshopper	beetle
(4)	grasshopper	butterfly	beetle

4. The table below shows the conditions that were provided for four seeds taken from the same type of plant, J, K, L and M.

Which seed will most likely germinate?

	Seed	Air	Water	Light	Temperature (°C)
(1)	J	present	absent	present	0
(2)	K	present	present	absent	32
(3)	L	absent	present	absent	25
(4)	M	absent	present	present	50

5. Diagrams 1 and 2 below show the reproductive parts of a plant and a human respectively.

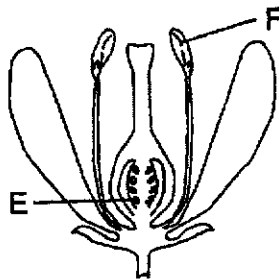

Diagram 1

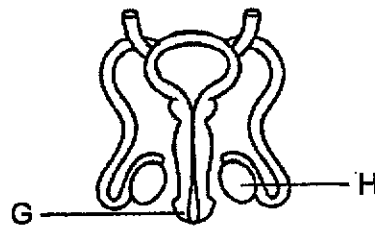
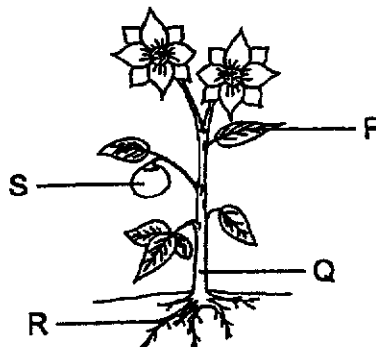

Diagram 2

Which of the following parts are responsible for the production of male reproductive cells?

- (1) E and G only
 - (2) E and H only
 - (3) F and G only
 - (4) F and H only
6. The diagram below shows a plant.



Which plant part, P, Q, R or S, has been matched correctly to its function?

	Part	Function
(1)	P	produces seeds
(2)	Q	holds the plant upright
(3)	R	takes in food from the soil
(4)	S	takes in oxygen to make food

7. The diagram below shows the direction of blood flow in the blood vessels W, X, Y and Z, in Jatin's body.

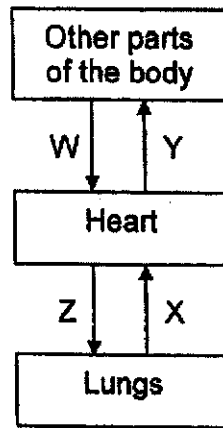

Which graph below shows the amount of carbon dioxide present in the blood flow of blood vessels at W and X?

(1)

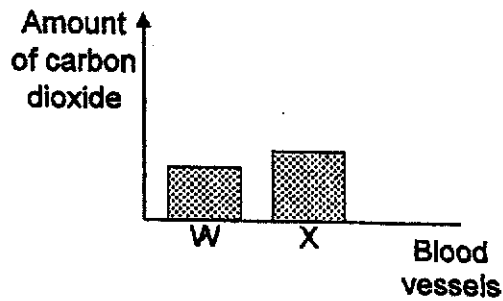

(2)

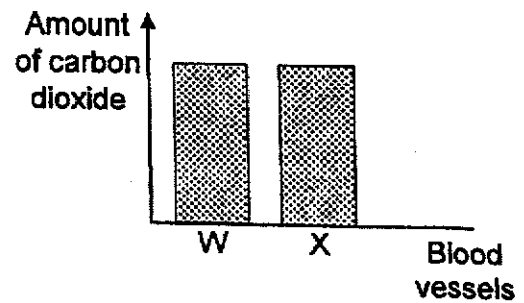

(3)

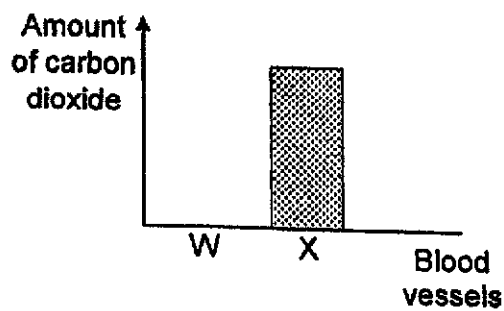

(4)

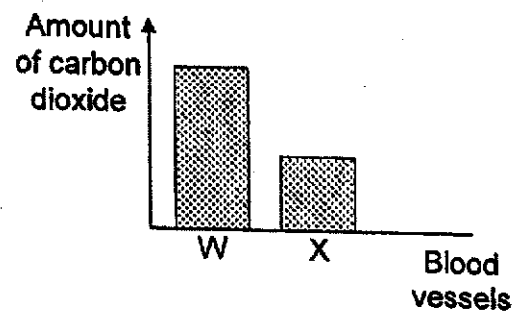

8. Study the flowchart below.

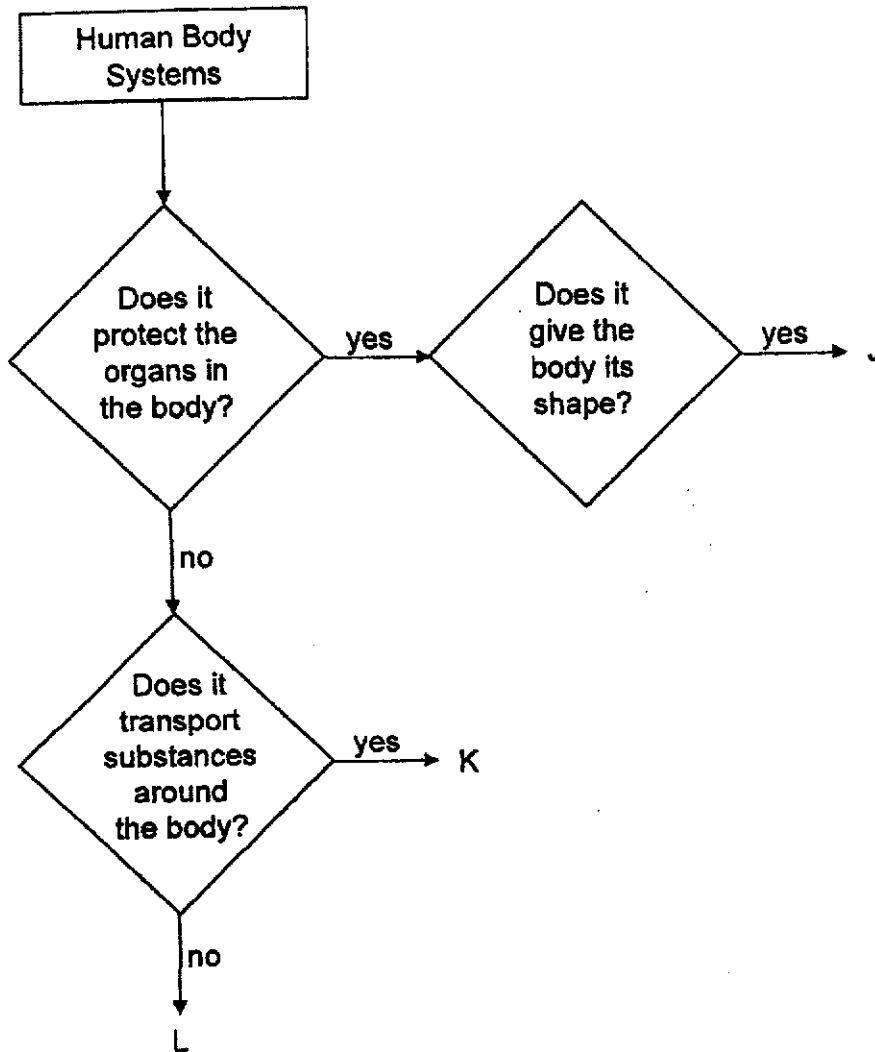

Based on the flowchart above, which systems do J, K and L represent?

	J	K	L
(1)	skeletal	circulatory	digestive
(2)	skeletal	respiratory	digestive
(3)	muscular	respiratory	circulatory
(4)	muscular	digestive	circulatory

9. The diagram below shows a food web in a community.

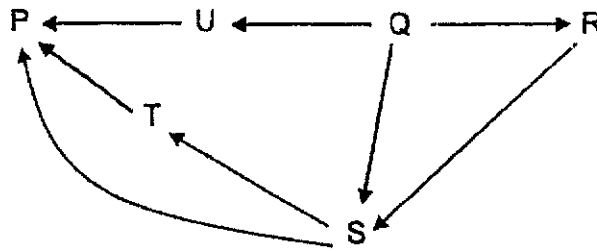

Which of the following correctly identifies organisms, P, Q, R, S, T and U?

	Producer	Prey only	Predator only	Prey and Predator
(1)	P	S, T	Q	R, U
(2)	Q	P, U	R	S, T
(3)	P	Q, R	S	T, U
(4)	Q	R, U	P	S, T

10. Bird V dives down from the sky and grabs its prey out of the water.

Which of the following correctly matches the foot of Bird V?

(1)



(2)

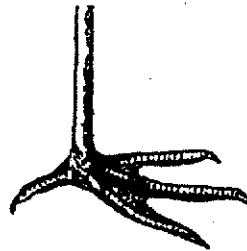

(3)



(4)

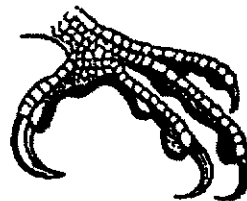

11. The food web below shows the relationship between organisms, E, F and G.

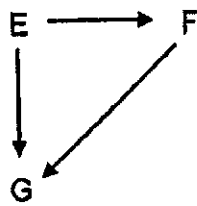

Organism H was introduced to the habitat as shown in the food web below.

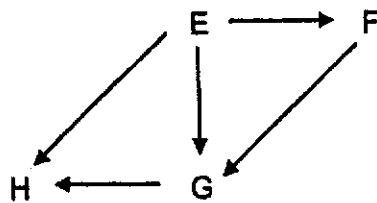

The graph below shows the number of organism G over a period of time. At which point of the graph was organism H first introduced?

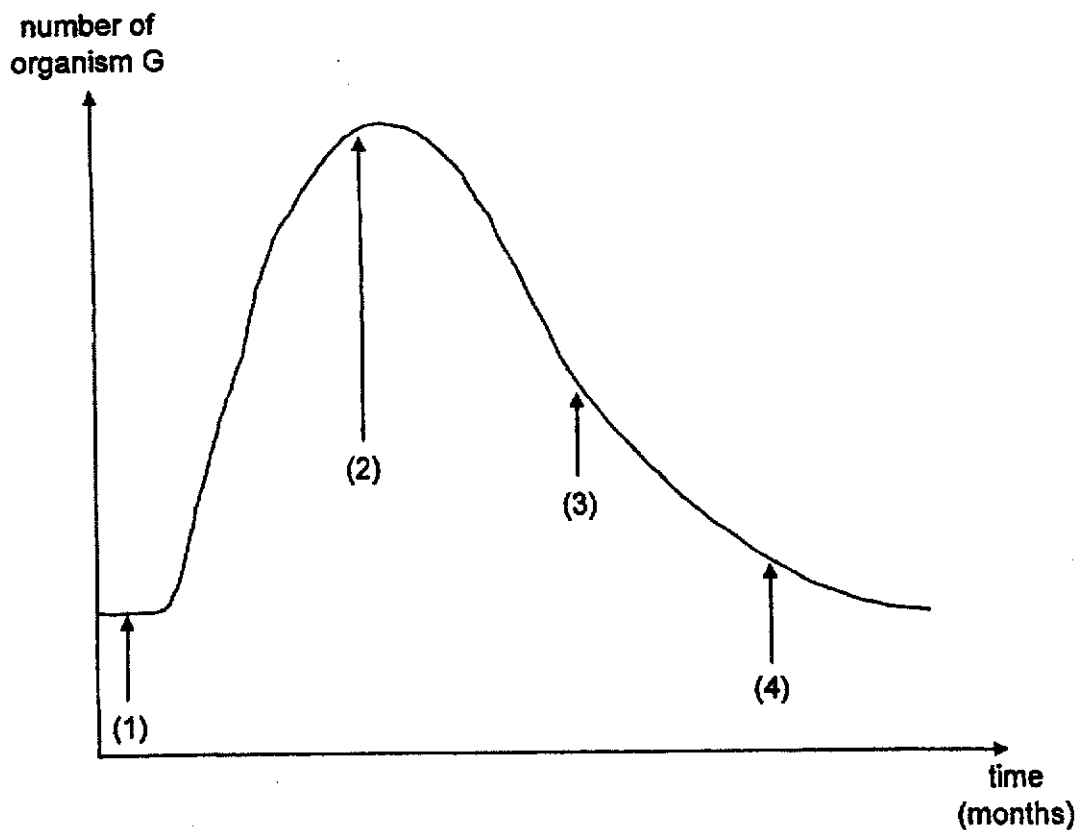

12. Animal waste from a farm flows into a river at point K. The arrow shows the direction in which the river flows.

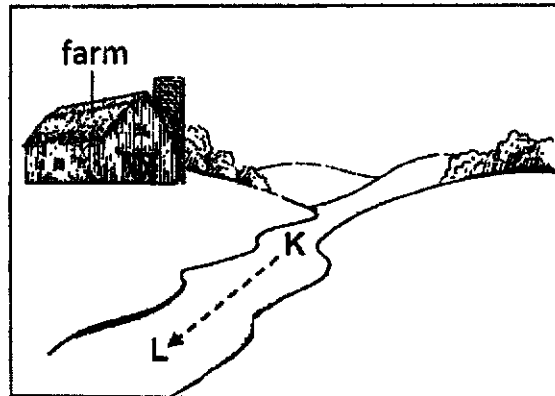

After some time, organisms living in the river after point K, died.

Which graph best represents the effect of the animal waste entering the river between point K and L?

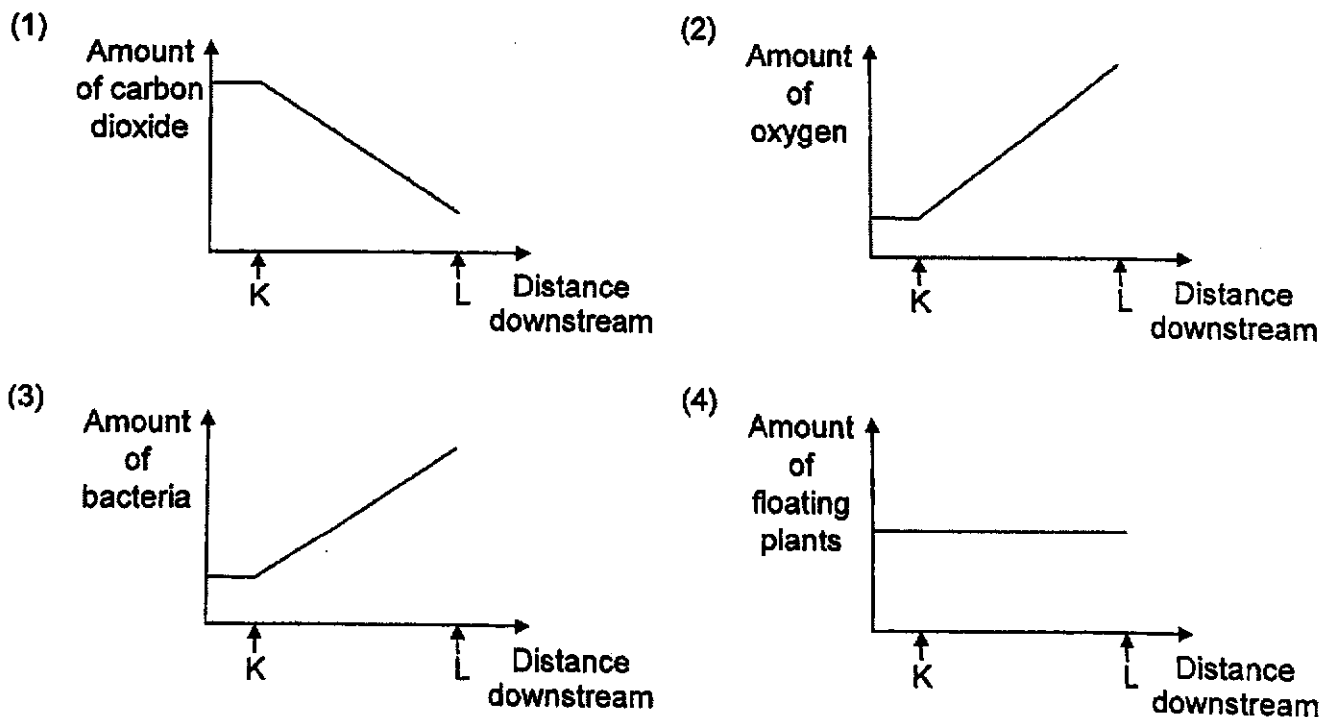

13. The diagram below shows a potted plant placed in the garden for a day from 6 a.m. to 11 p.m. One of the leaves is placed in a clear plastic bag containing liquid L, which was red in colour in the beginning.

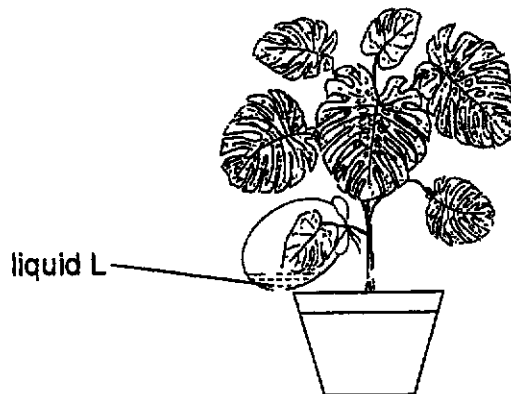

The table below shows the changes in the colour of liquid L with different amounts of carbon dioxide present in the bag.

Colour	Amount of carbon dioxide
red	same as the amount in the air
purple	less than the amount in the air
yellow	more than the amount in the air

What would be the colour of liquid L in the plastic bag at 10 a.m. and 10 p.m. respectively?

	Colour of liquid L	
	At 10 a.m.	At 10 p.m.
(1)	yellow	purple
(2)	yellow	red
(3)	purple	yellow
(4)	red	yellow

14. The table below shows the organs involved in the absorption and digestion of food. Which of the following is correct?

	Organ involved in the absorption of food	Organ involved in the digestion of food
(1)	large intestine	small intestine
(2)	small intestine	large intestine
(3)	small intestine	small intestine
(4)	large intestine	large intestine

15. Firefighters wear safety suits that help them to stay safe while they put out fires.



Based on the properties shown below, which material is the most suitable for making the safety suits?

	Property			
	Strong	Flexible	Waterproof	Heat Conductivity
(1)	✓	✓	✓	good
(2)	✓	✓	✓	poor
(3)	✗	✓	✗	poor
(4)	✗	✗	✓	good

Key
 ✓ : Yes
 ✗ : No

16. Which of the following is not an example of matter?

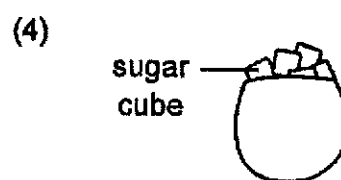
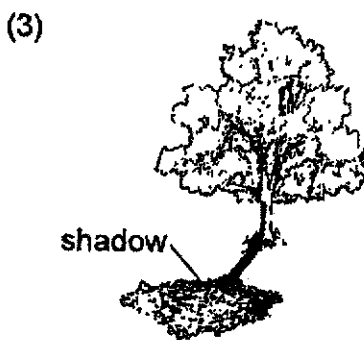
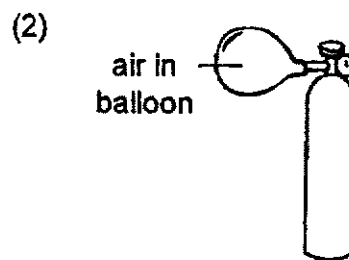
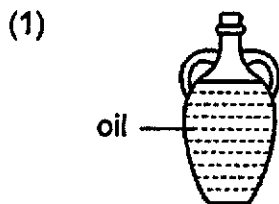

17. Hassan wanted to investigate if the amount of exposed surface area of water affects the rate of evaporation. Containers C, D, E and F, are made of the same material but filled with different amounts of water as shown below.

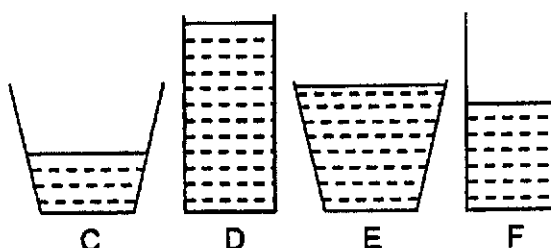

Container	Amount of water in the container (ml)
C	40
D	90
E	90
F	40

Which containers could he use for his experiment?

- (1) C and E
 - (2) D and E
 - (3) D and F
 - (4) E and F
18. Study the circuit diagram below. The batteries and bulbs are in working condition.

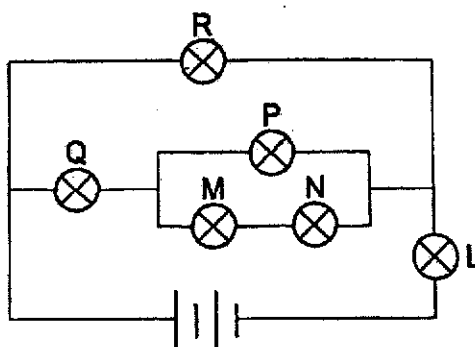

Which of the following correctly states the number of bulb(s) that would still be lit when one or more bulbs are blown?

	Bulb(s) that is/are blown	Number of bulb(s) still lit
(1)	L	1
(2)	N	3
(3)	M and P	2
(4)	Q and R	4

19. Two identical glasses are placed at positions, R and S, on the balance scale as shown below.

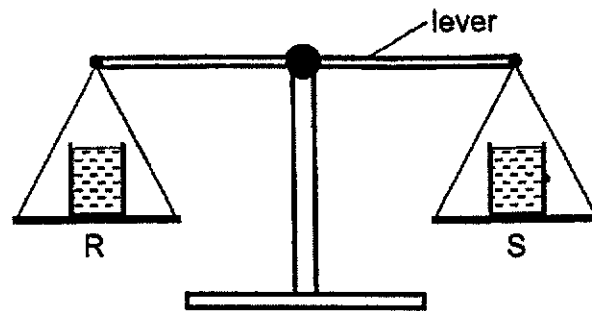

Some water from the glass at position R was then removed.

Which of the following will be observed and which property of water causes this observation?

	Observation	Property of water
(1)	Lever tilted downwards at position S	Water has mass.
(2)	Lever tilted downwards at position S	Water takes up space
(3)	Lever tilted downwards at position R	Water has a definite volume.
(4)	Lever tilted downwards at position R	Water cannot be compressed

20. Indra dives into a swimming pool from position J and hits the pool at position M.

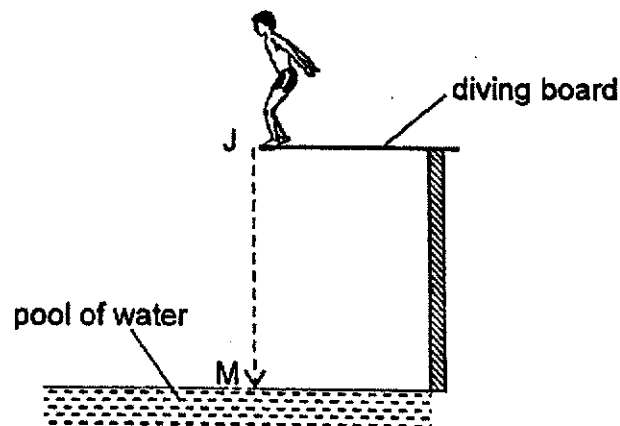

Which of the following shows the correct change in the amount of energy from J to M?

	Change in potential energy from J to M	Change in kinetic energy from J to M
(1)	decrease	increase
(2)	decrease	decrease
(3)	increase	decrease
(4)	increase	increase

21. The diagram below shows four materials, E, F, G and H.

Sheets E and F had cut-outs of different shapes as shown below. A bright patch of light, in the shape of a star, was observed on sheet G when the torch was turned on.

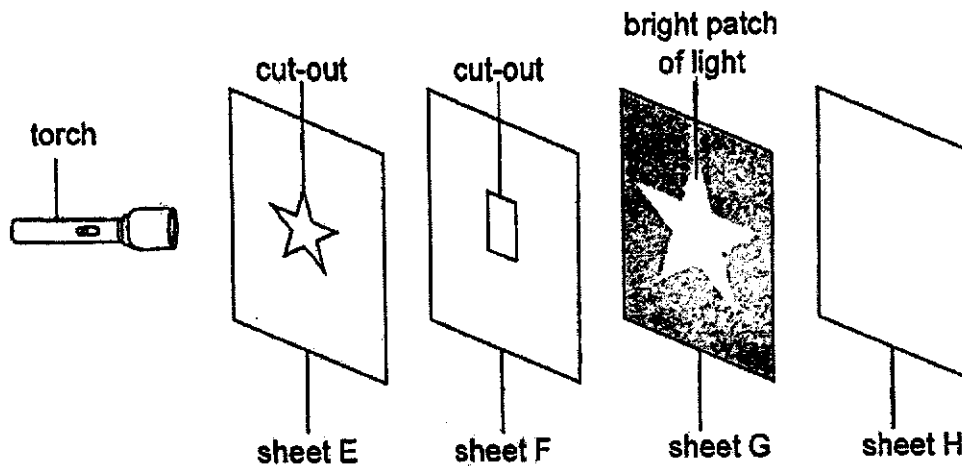

Which of the following correctly describes the properties of sheets, E, F, G and H?

	Allows light to pass through	Does not allow light to pass through	Not possible to tell
(1)	H	E	F and G
(2)	F	E and G	H
(3)	F	G	E and H
(4)	G and H	F	E

22. The set-up below investigates the magnetic strength of four different bar magnets, A, B, C and D. The number of iron nails that are attracted to each bar is recorded in the table below.

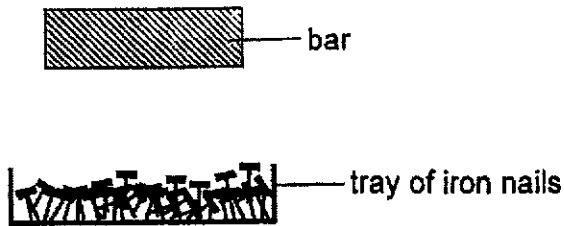

Bar	Number of iron nails attracted
A	10
B	15
C	6
D	28

Which arrangement of the bars, in descending order of magnetic strength, is correct?

- (1) C, B, A, D
 - (2) D, A, B, C
 - (3) C, A, B, D
 - (4) D, B, A, C
23. The diagram below shows Jack on a pogo stick. He jumps on the pogo stick at P to compress the spring in the pogo stick, which in turn causes him to move to Q when the spring returns to its original shape.

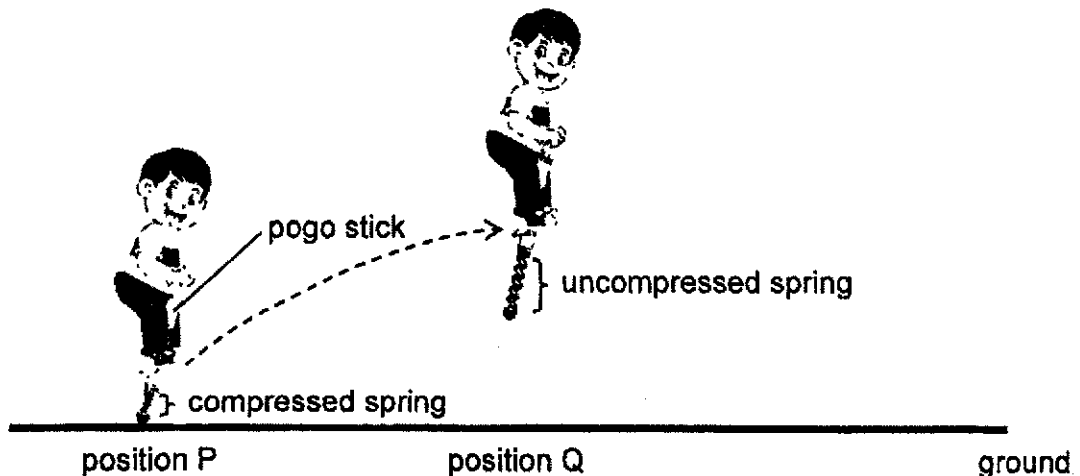

Which of the following statements is true as Jack moves from position P to Q?

- (1) Frictional force is not acting on the boy.
- (2) Gravitational force acting on the boy is increasing.
- (3) Elastic spring force acting on the pogo stick is increasing.
- (4) Elastic spring force is acting on the boy in the opposite direction of his weight.

24. The diagram below shows a home-made toy airplane. The rubber band was twisted by rotating the propeller twenty times. When the propeller was released, the toy airplane moved forward.

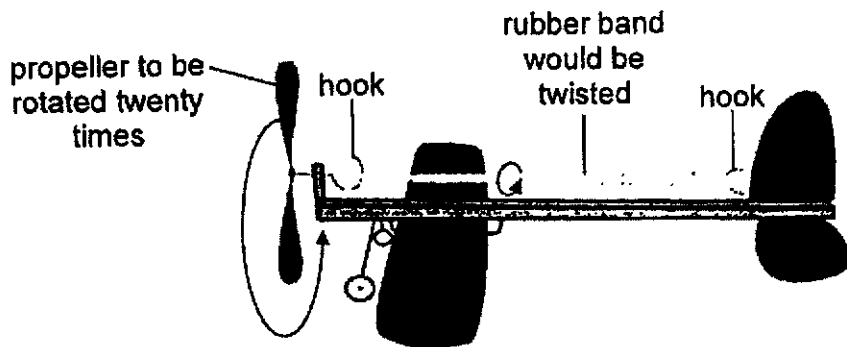

Which of the following shows the correct energy conversion when the propeller was released?

- (1) potential energy (rubber band) → kinetic energy (rubber band) → heat energy + sound energy (propeller)
- (2) kinetic energy (rubber band) → potential energy (rubber band) → kinetic energy + sound energy (propeller)
- (3) potential energy (rubber band) → kinetic energy (rubber band) → kinetic energy + sound energy (propeller)
- (4) potential energy (rubber band) → potential energy (propeller) → kinetic energy + sound energy (propeller)

25. Mathilda threw a ball into the net as shown in the diagram below.

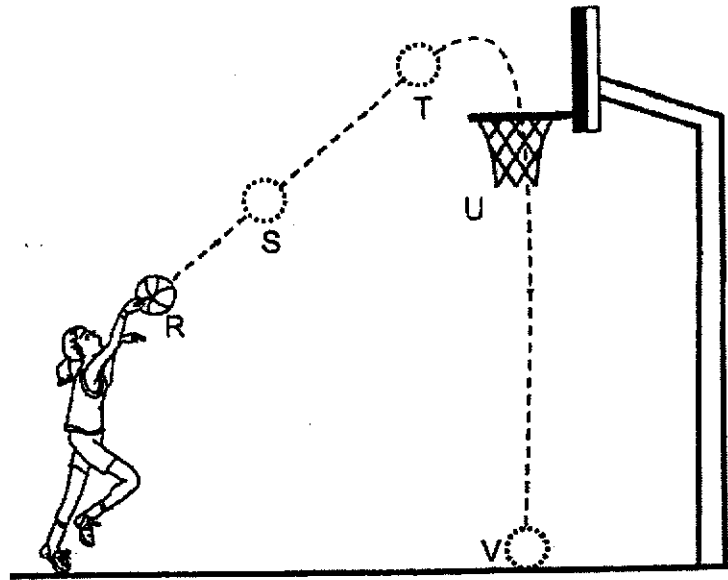

Which of the following statements is/ are correct?

- A There are no forces acting on the ball at V.
- B A force is exerted on the ball at R, to move the ball.
- C There is no frictional force acting on the ball when it moves from U to V.

- (1) B only
- (2) C only
- (3) A and B only
- (4) A and C only

26. Meenah placed four raw fish balls into two identical containers, W and X, which were placed on the kitchen table. They were filled with different amounts of hot water. Her mother told her that the fish balls will float up when they are cooked.

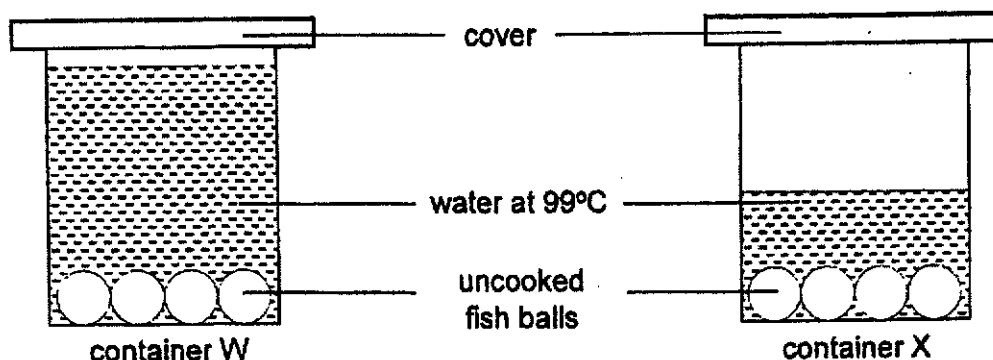

Which of the following explains Meenah's observation of the fish balls in containers, W and X, at the end of 15 minutes?

	Observation	Reason
(1)	It took a longer time for all the fish balls in container X to float up.	The amount of heat energy in both containers is the same.
(2)	It took a longer time for all the fish balls in container X to float up.	There is less heat in container X.
(3)	Fish balls in both containers took the same length of time to float up.	The temperature of the water in both containers is the same.
(4)	It took a longer time for all the fish balls in container W to float up.	There is more heat in container W.

27. Bailey wanted to install two light bulbs, a fan and two switches, Y and Z, in her living room. The table below shows her observations when different switches were closed.

Switches		Observations	
Y	Z	Number of bulbs lit	Fan blade spun
open	closed	1	Yes
closed	open	1	No
closed	closed	2	Yes

Which of the circuits below correctly matches the observations made above?

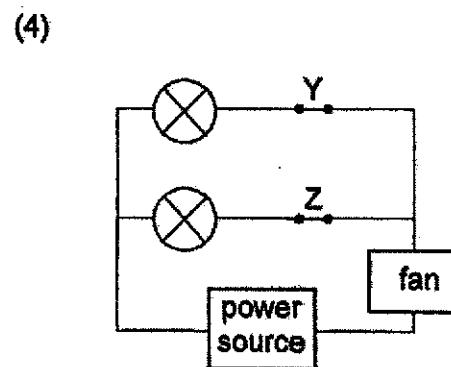
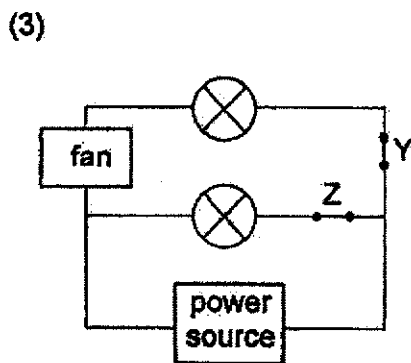
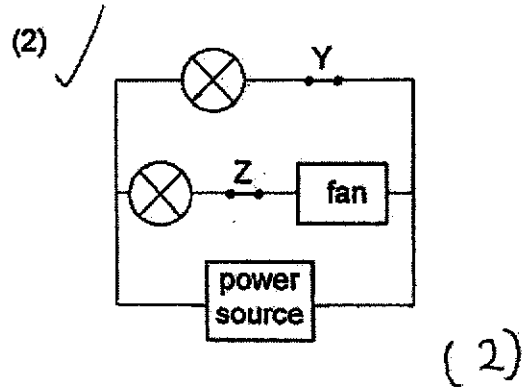
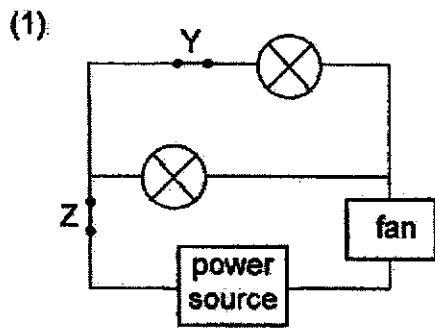

28. In the diagram below, the rubber band in the butterfly toy was twisted thirty rounds to wind it up fully before it was released at A. The toy flew up before landing at B. The graph below shows the different types of energy the toy has at A.

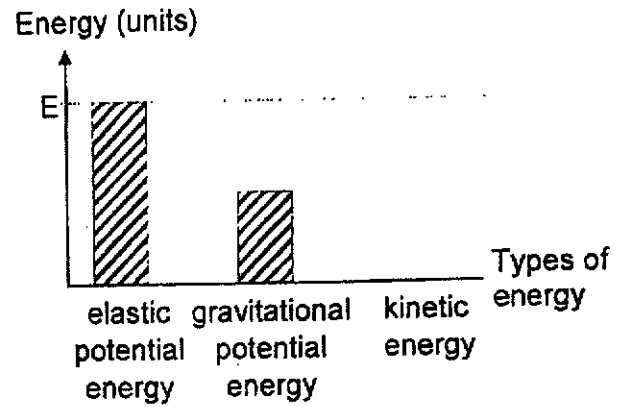
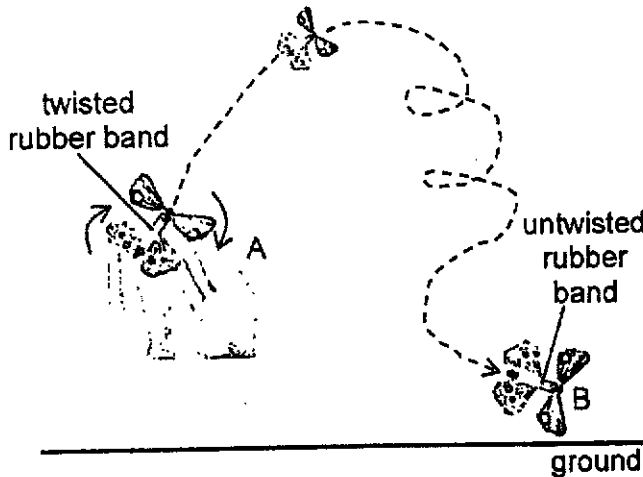

Which of the following graphs shows the amounts of different types of energy for the toy at B before it touched the ground?

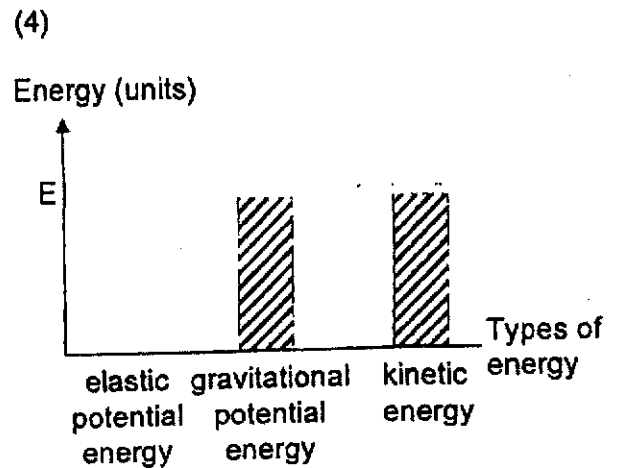
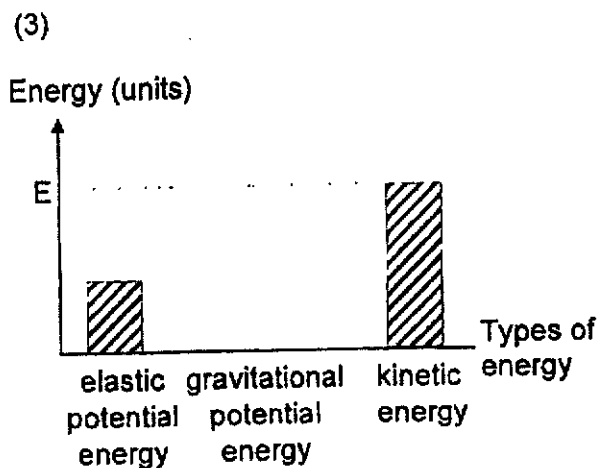
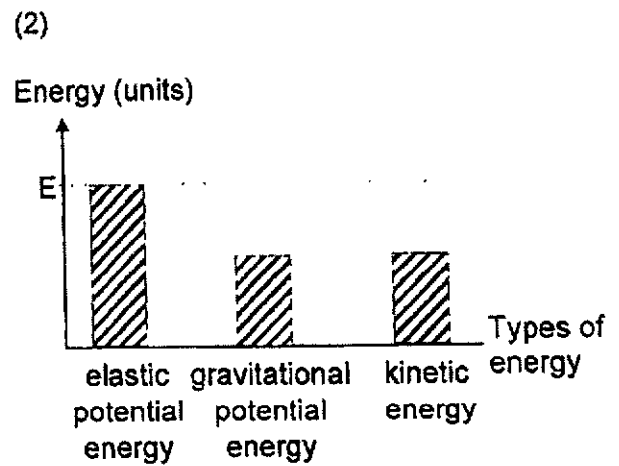
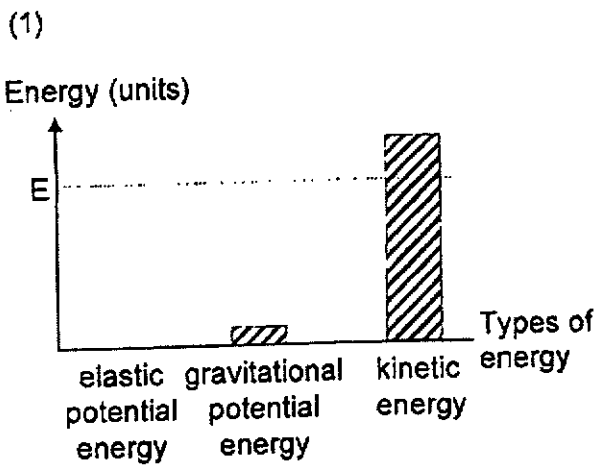



2022 PRIMARY 6 PRELIMINARY EXAMINATION

Name : _____ ()

Date: 23 August 2022

Class : Primary 6 ()

Time: 8.00 a.m. – 9.45 a.m.

Parent's Signature : _____

Duration: 1 hour 45 minutes

SCIENCE

BOOKLET B

INSTRUCTIONS TO CANDIDATES

1. Write your name, class and register number.
2. Do not turn over this page until you are told to do so.
3. Follow all instructions carefully.
4. Answer all questions.
5. Use a dark blue or black ballpoint pen to write your answers in the space provided for each question.
6. Do not use correction fluid/ tape or highlighter.

Booklet A	56
Booklet B	44
Total	100

For questions 29 to 41, write your answers clearly in this booklet.

The number of marks available is shown in brackets [] at the end of each question or part question.

(44 marks)

29. Three animals, A, B, and C, are shown below.

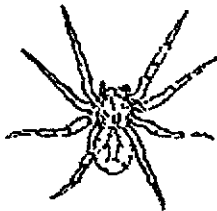

A



B



C

(a) Based on the diagrams above, complete the flowchart below with the correct letters, A and B, in the boxes given. [1]

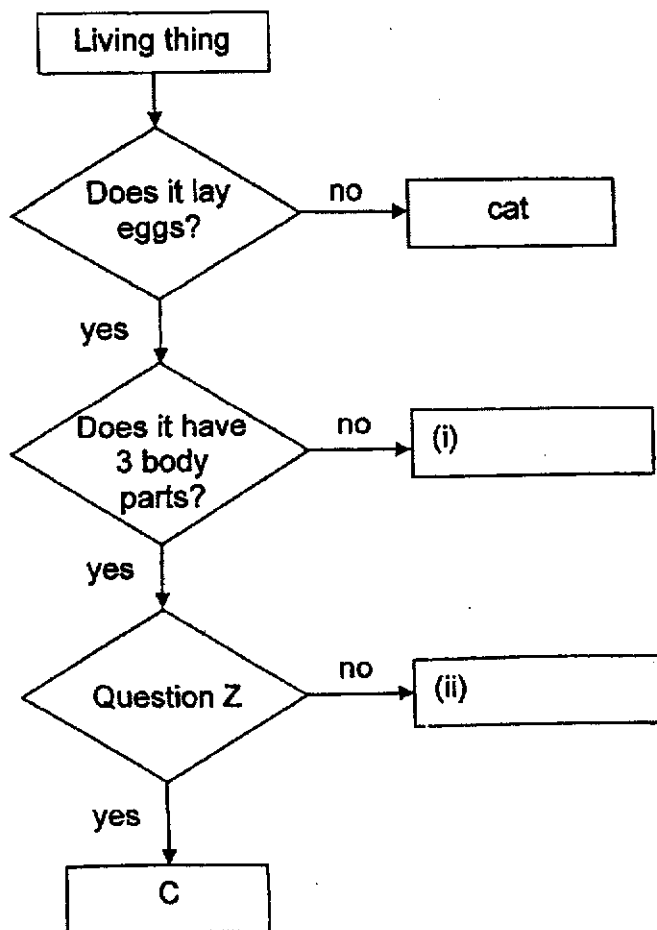

Score : 1

(b) Based on the diagrams and information given in the flowchart, state what Question Z is. [1]

(c) Name another animal that has the same characteristics as animal C. [1]

30. Ali ate some bread. The amount of undigested bread just before it leaves the different parts of his digestive system, P, Q and R, is measured over three hours. The results are recorded in the bar graph shown below.

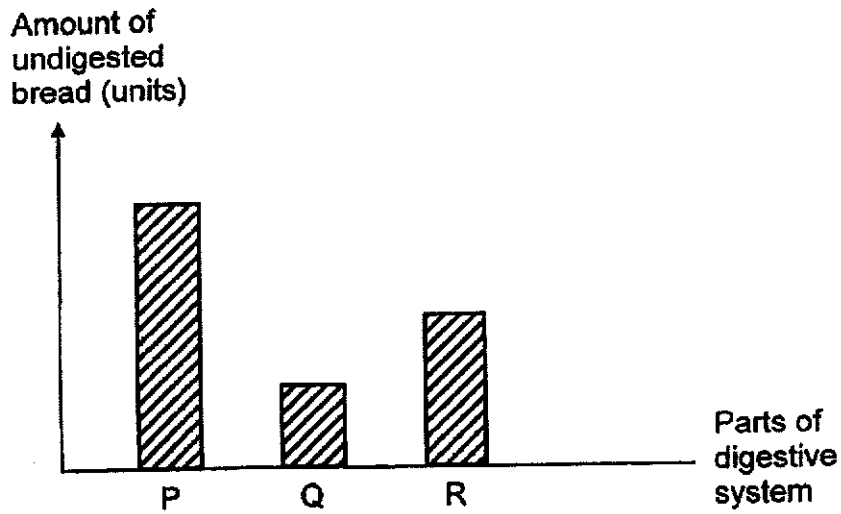

- (a) Fill in the boxes below with P, Q and R to match the parts of the digestive system shown above. [1]

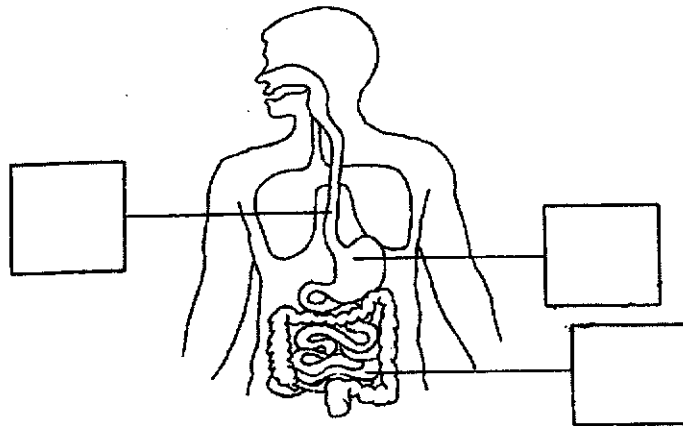

- (b) Explain why the amount of undigested food decreased from R to Q. [1]

- (c) Explain how teeth help in the digestion of food. [2]

31. Study the diagram below.

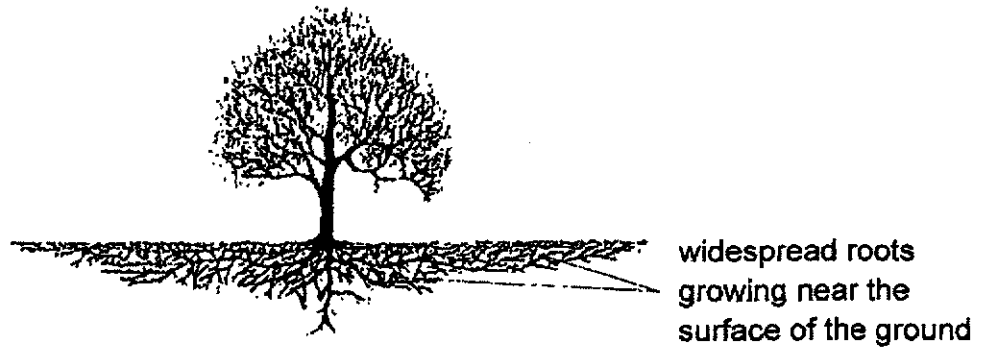

(a) Explain how the adaptation of the tree roots shown above helps the tree to survive in a place with little rainfall. [1]

The plant shown below has storage roots. The outer ring of the stem containing food-carrying tubes was removed.

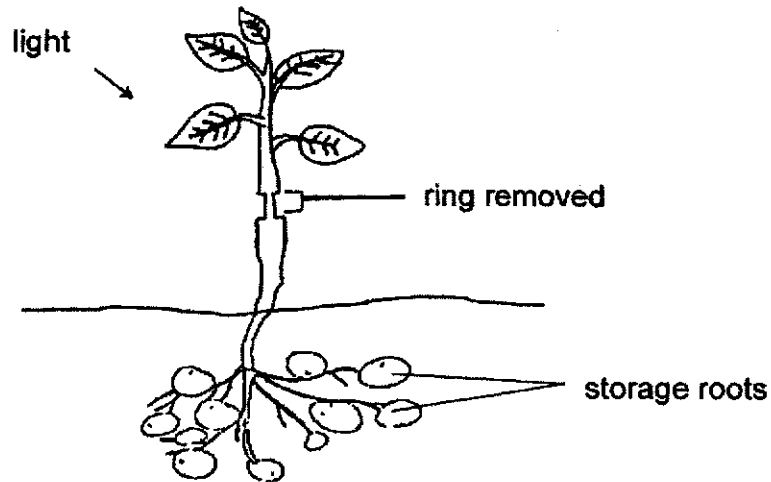

The plant was left under the sun and watered daily. After a week, it was observed that the plant was alive and the part of the stem above the cut was swollen.

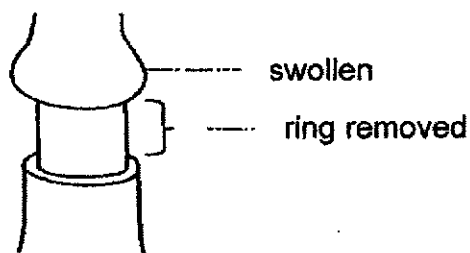

5

Score	1
-------	---

Study the graph shown below.

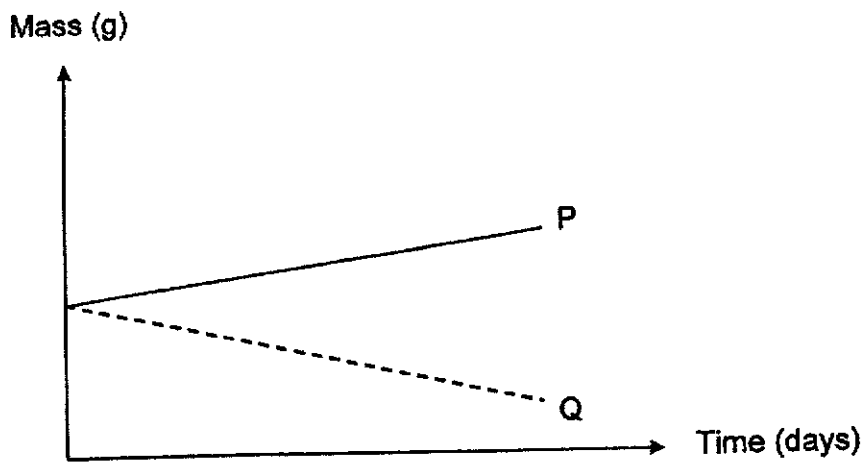

(b) Which graph, P or Q, shows the likely change in the mass of the storage roots over the week? Explain why. [1]

[Score [1]]

32. Organism A grows in soil that is poor in nutrients in the forest. It is adapted to digest insects. Organism B only feeds on fruits.

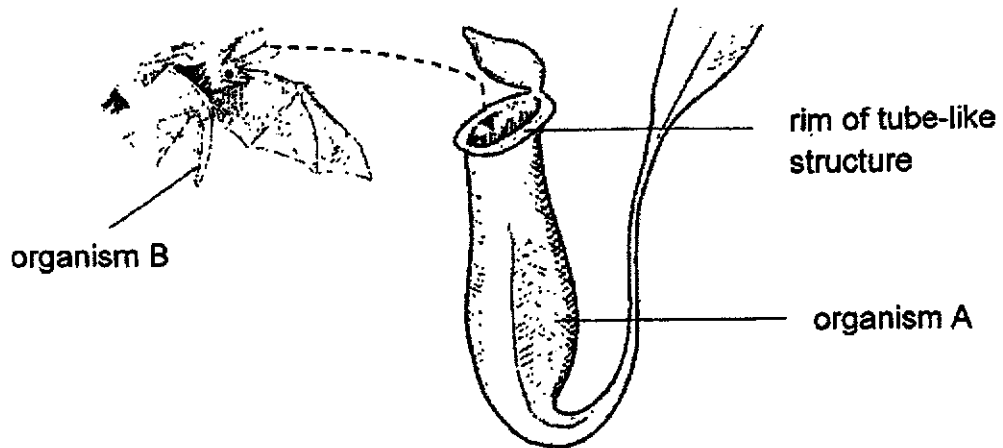

- (a) Organism A has a slippery substance at the rim of its tube-like structure. Explain how the slippery substance helps organism A to catch insects. [2]

- (b) Organism B goes into the tube-like structure of organism A to rest in the day instead of hanging from a tree in the forest. Explain how this behavioural adaptation helps organism B to survive in the forest. [1]

- (c) Organism B produces droppings when it is resting inside organism A. Explain how this helps organism A to survive better. [1]

Score	4
-------	---

33. Rachel conducted an experiment using the set-ups below. She placed two test tubes, A and B, with the same amount of water at different corners of a dim room.

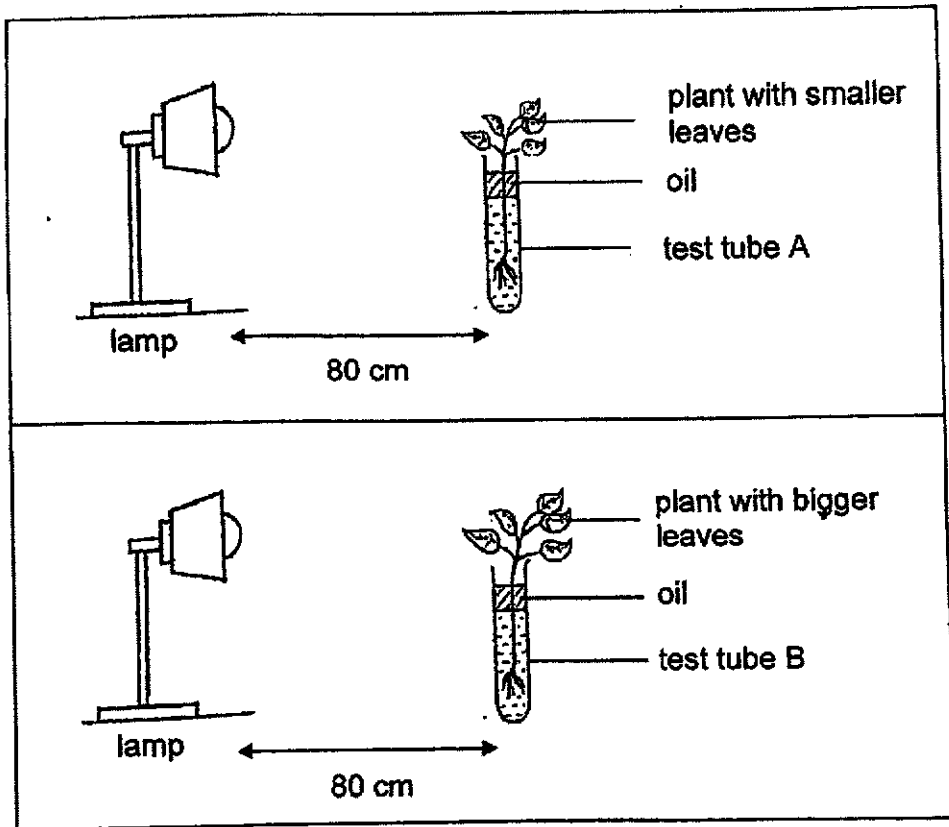

The graph shows the change in the amount of water in the test tubes over a period of time when the lamps were switched on.

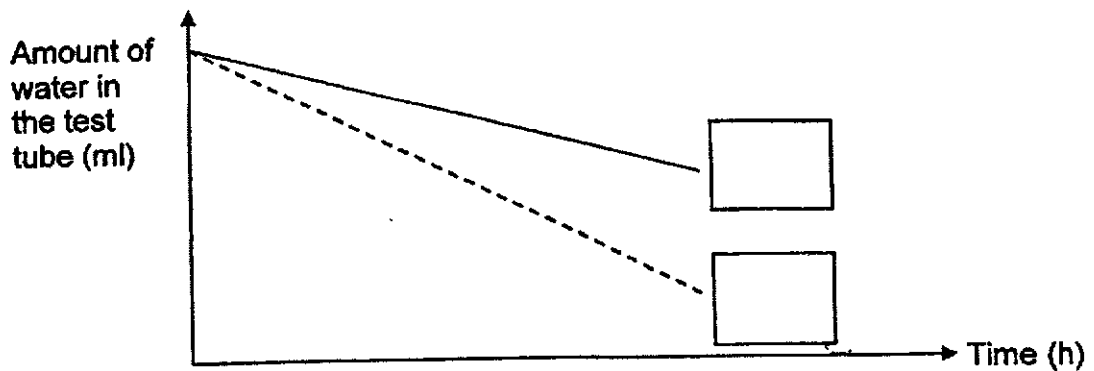

- (a) Tick (\checkmark) the box beside the line that shows the results of test tube B. [1]
- (b) Based on the information above, what is the aim of this experiment? [1]

- (c) The distance between the lamp and the plant in the experiment was kept the same. Explain how this makes it a fair test. [1]

Rachel grew some plants in two different plots of land, R and S. She predicts that more fruits will be produced by adding 5g of fertiliser to the soil around each plant. However, her friend predicts that adding 10g of fertiliser will produce more fruits.

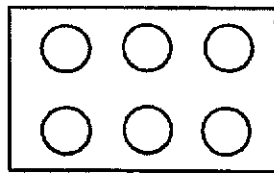

R

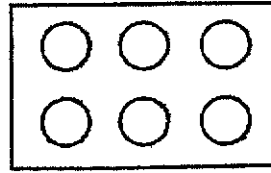

S

- plant with 0 g of fertiliser added
- plant with 5 g of fertiliser added
- plant with 10 g of fertiliser added

- (d) Tick (✓) two boxes to show the two arrangements of plants Rachel should use to conduct an experiment to confirm their hypotheses. [1]

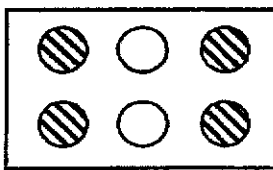

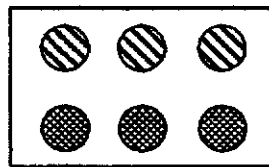

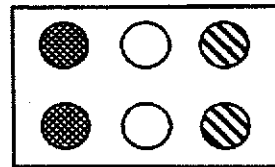

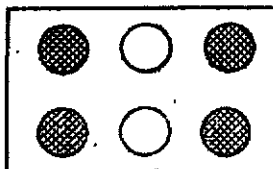

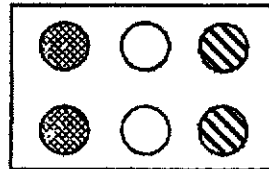

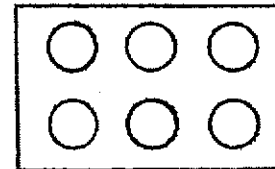

- (e) Which variable is being kept constant in your answer in part (d)? [1]

Score	3
-------	---

34. Shuling wanted to find out if the intensity of the smell of flowers affects the number of insects visiting the flowers. She made flowers with petals of the same size using cards of the same colour. Then she added different number of drops of sweet-smelling substance to the centre of each flower. The flowers were left in an open field.

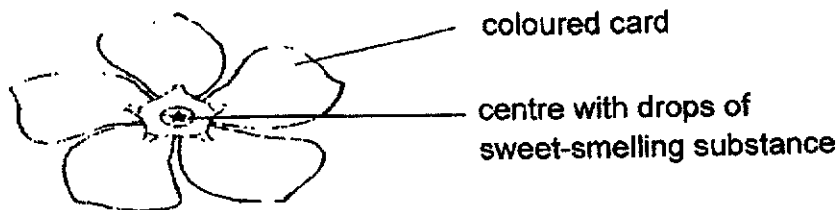

The number of insects that visited the flowers over three hours was recorded in the table below.

Number of drops of sweet-smelling substance	Number of insects visiting the flowers		
	1 st hour	2 nd hour	3 rd hour
5	8	6	1
10	9	10	5
15	10	12	8

- (a) Based on the results, what can you conclude about the intensity of the smell of flowers and the number of insects visiting the flowers? [1]

- (b) Why is it an advantage for the plant if the flowers are more sweet-smelling? [1]

- (c) Suggest two changes to be made to the set-up if Shuling wants to find out if the size of the petals affects the number of insects visiting the flowers. [2]

35. Three similar strips made of different materials, A, B and C, were put into a container with water as shown below. All the strips were removed after one minute.

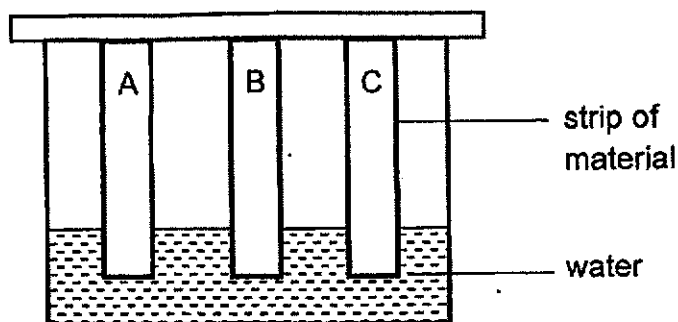

The amount of water absorbed by each strip is shown below.

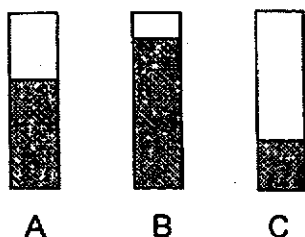

Key:

□ without water

■ with water

- (a) Based on the information given, which of the materials, A, B or C, is most suitable for making swimwear so that the swimmer can move easily in water? Explain why. [1]

- (b) State another property of material used to make swimwear that enables the user to move easily in water. Give a reason for your answer. [1]

Score

36. (a) What is evaporation?

[1]

Two containers of 100 ml of water as shown below were left in the open for three hours.

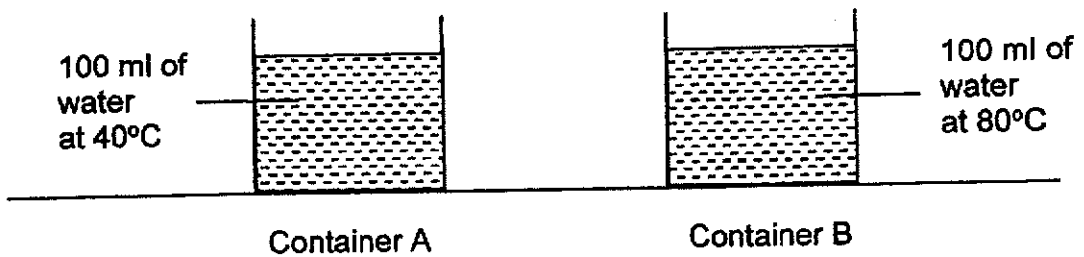

(b) Fill in a possible volume of water left in container A after three hours in the table below. [1]

Container	Amount of water left (ml)
A	
B	80

(c) Explain your answer in part (b).

[1]

Score	3
-------	---

The table below shows the change in the temperature of wet clothes in a washing machine which uses hot water after the wash has ended.

Length of time after the wash has ended (min)	Temperature of the wet clothes ($^{\circ}\text{C}$)
0	60
30	50
60	40

- (d) How long after the wash should Krystal hang the clothes so that they dry the fastest? Explain why. [1]

Score	1
-------	---

37. A baby cradle is hung from the ceiling as shown below. The spring will extend further when the cloth is being pulled downwards to rock the baby up and down.

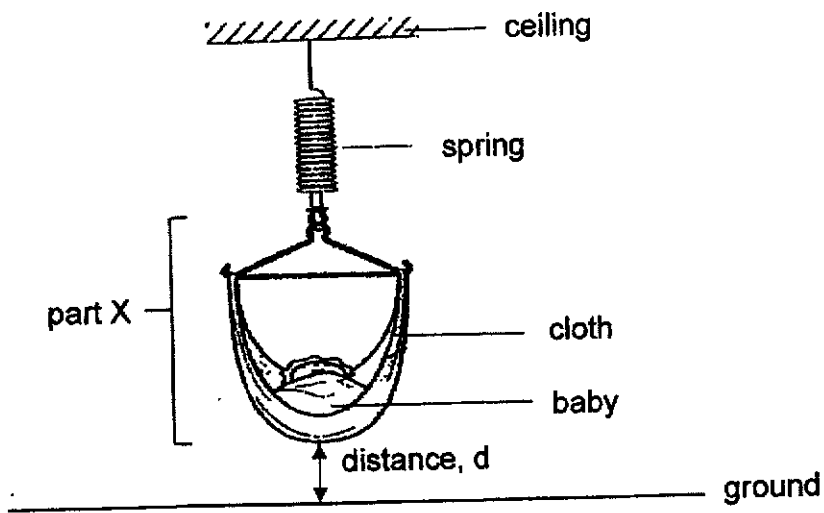

- (a) What forces are acting on part X when the baby is placed in the cradle? [1]

The set-up below shows the length of four different springs, W, X, Y and Z, when weights are added to them.

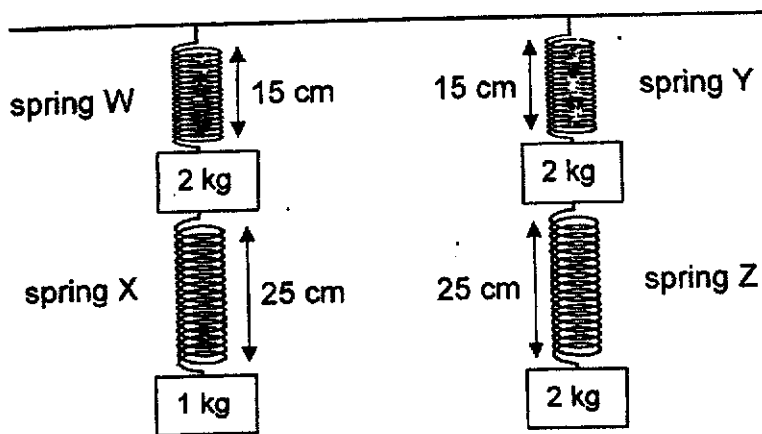

- (b) Which spring, W, X, Y or Z, should be used for the cradle to ensure that the baby does not hit the ground as the baby grows heavier? Explain your answer using distance, d . [2]

Score	3
-------	---

38. Jack blew a bubble using soapy water in an open field. The bubble floated a distance before it burst when it touched the ground.

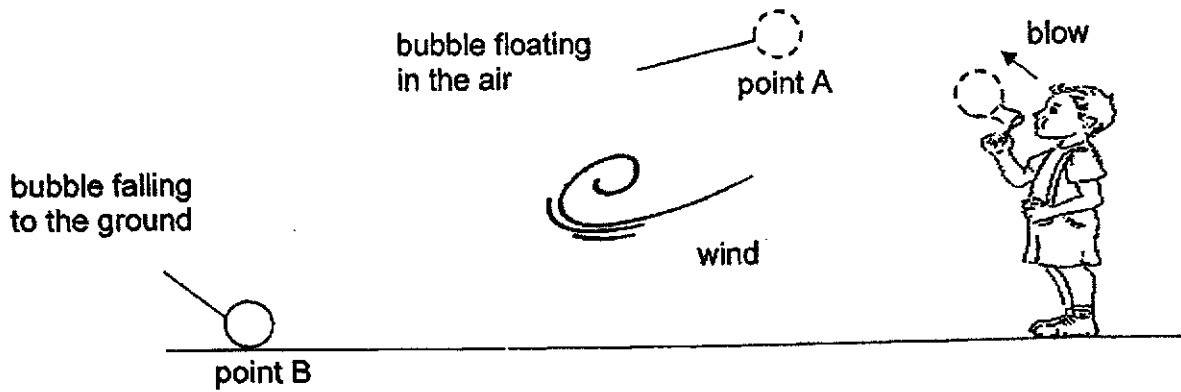

- (a) Complete the graph below to show the amount of gravitational force acting on the bubble at point B. [1]

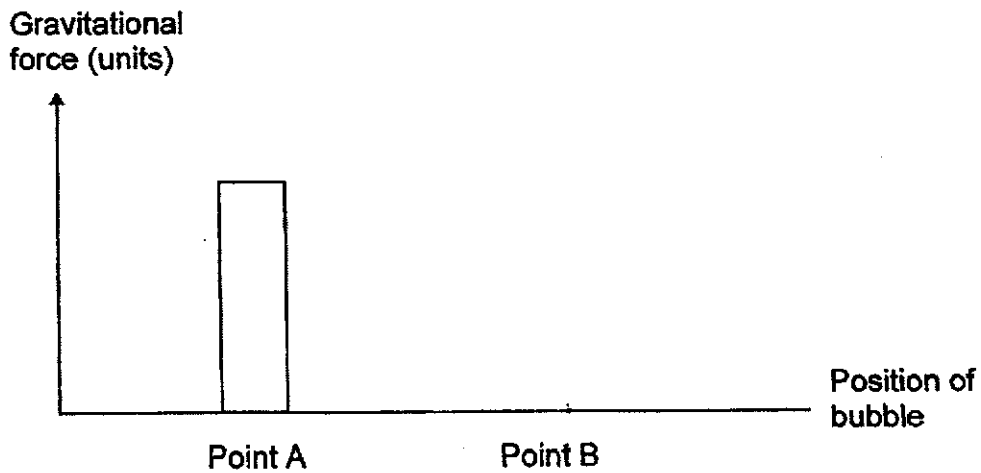

- (b) Name two forces, other than gravity, and explain their effects on the bubble from the time it was blown away from Jack till it burst on the ground. [2]

(i) Force: _____

Explanation: _____

(ii) Force: _____

Explanation: _____

39. The functions of the electrical components in the circuit of a toy robot are given in the table below.

Electrical component	Function
M1	move forward
M2	move backward
S	beep

- (a) Complete the circuit diagram below to form a closed circuit so that the robot only moves forward and both the bulbs light up at the same time. [2]

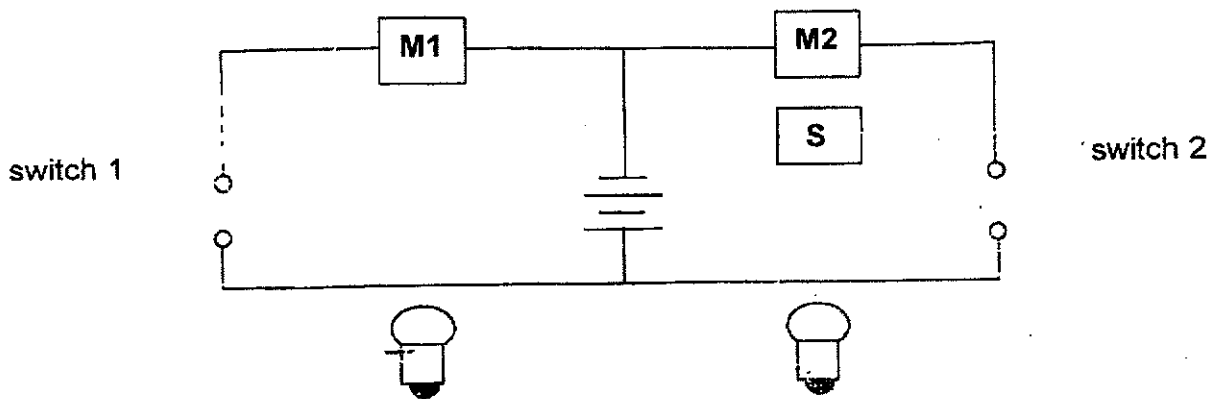

- (b) Draw wires in the diagram above to show how the sound box, S, should be connected so that it will beep only if the robot needs to move backwards. [1]

40. Sany conducted an experiment on photosynthesis in a dark room using the set-up below.

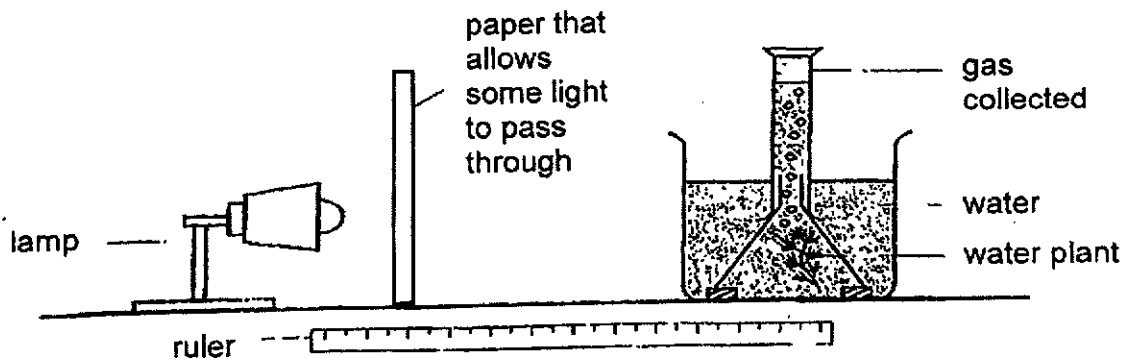

Score 3

Samy repeated the experiment by increasing variable X and keeping all other variables constant. His results are shown below.

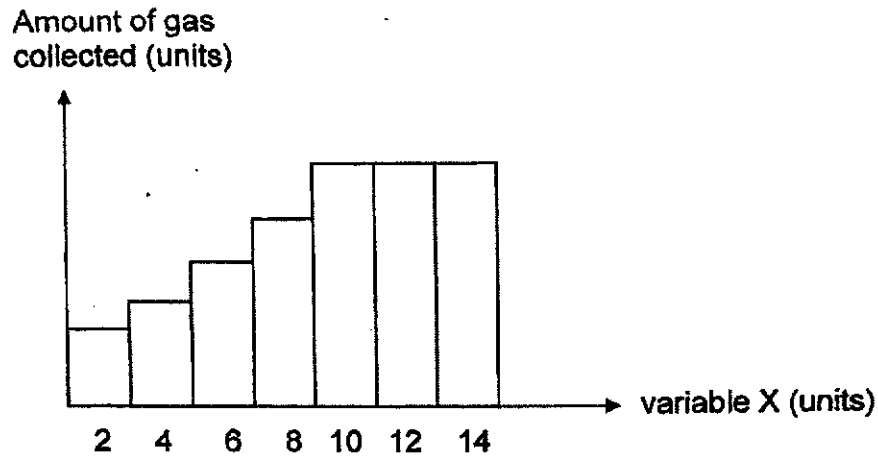

(a) What is the relationship between variable X and the amount of gas collected? [1]

(b) What could variable X be? [1]

(c) Explain how an increase in variable X could cause an increase in the amount of gas collected. [1]

(d) The amount of gas collected did not change after some time even when variable X was increased. Suggest a reason for the observation made. [1]

Score	4
-------	---

41. Harry is pedalling on a stationary bicycle which lights up a signboard.

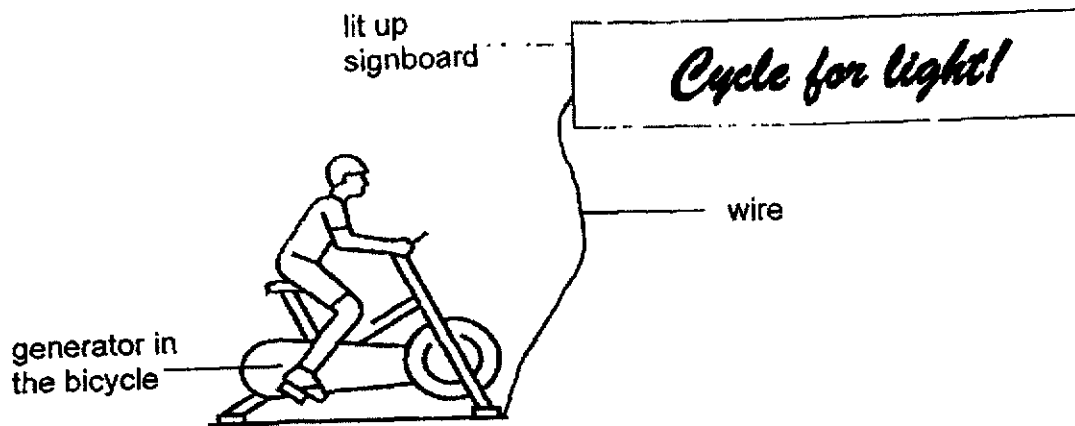

(a) Fill in the boxes to show the energy conversions as Harry pedals the bicycle to light up the signboard. [1]

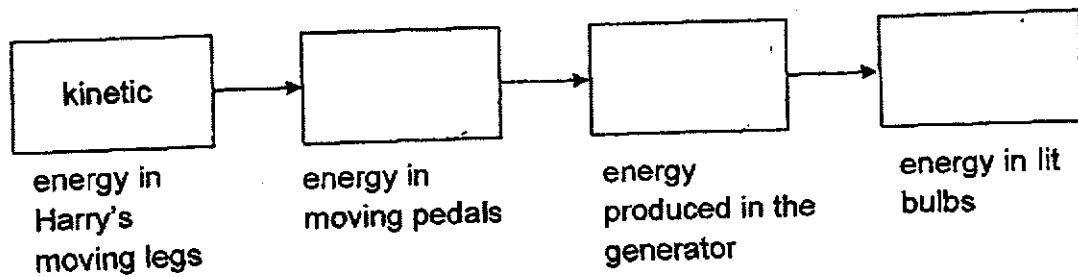

(b) Harry cycled slower after 30 minutes. What will be observed about the brightness of the bulb when he cycled slower? Explain your answer in terms of energy conversion. [2]

End of Paper

Score	3
-------	---

SCHOOL : TAO NAN PRIMARY SCHOOL
LEVEL : PRIMARY 6
SUBJECT : SCIENCE
TERM : 2022 PRELIM

SECTION A

Q 1	Q2	Q3	Q4	Q5	Q6	Q7	Q8	Q9	Q10
3	3	2	2	4	2	4	1	4	4
Q 11	Q12	Q13	Q14	Q15	Q16	Q17	Q18	Q19	Q20
2	3	3	3	2	3	2	3	1	1
Q 21	Q22	Q23	Q24	Q25	Q26	Q27	Q28		
2	4	4	3	1	2	2	1		

TAO NAN SCHOOL
P6 SCIENCE PRELIMINARY EXAM 2022
Simplified Answer Key (Booklet B)

This answer key only serves as a reference. Variations of students' answers have been accepted if they have shown conceptual understanding.

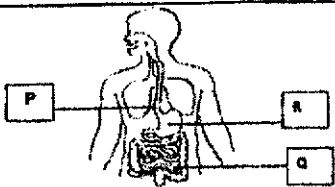
29 (a)	(i) A (ii) B
29 (b)	Does it have wings?
29 (c)	Dragonfly /damselfly /mosquito /butterfly /moth /cockroach
30 (a)	 <p>The diagram shows a human torso with the digestive system highlighted. A box labeled 'P' is connected to the mouth. A box labeled 'R' is connected to the stomach. A box labeled 'Q' is connected to the small intestine.</p>
30 (b)	Digestion took place
30 (c)	Teeth break food down into smaller pieces which increases exposed surface area of food to digestive juices.
31 (a)	Roots of plant B are widespread/near the surface so they can absorb more water.
31 (b)	Graph Q. The mass of the storage roots decreases as food made by the leaves cannot be transported to the roots so the stored food is used by the roots to survive.
32 (a)	Slippery substance reduces friction between the insect and the rim and causes the insects to fall/slip into the tube-like structure.
32 (b)	Organism B is able to hide from its predators /avoid being spotted easily by its predators.
32 (c)	Organism A is able to obtain nutrients from the droppings to grow more healthily.
33 (a)	Tick the dotted line graph.
33 (b)	To find out if the size of the leaves affects the amount of water lost from the leaves/amount of water taken in by the plant/amount of water left in the test tube.
33 (c)	To ensure that the amount of light does not affect the results/the amount of water lost from the plant/ the amount of water left in the tube/ the amount of water taken in by the plant. OR To ensure that <u>only</u> the size of the leaves will affect the results/amount of water left in the tube.
33 (d)	Tick the 3rd box in the top row and the 2nd box in the bottom row
33 (e)	Amount of plant/Type of plant/Amount of water given to each plant/Type of fertiliser
34 (a)	As intensity of smell of the flowers increases, number of insects visiting the flowers increases.
34 (b)	When flowers are more sweet-smelling, they attract more insects for pollination to take place.

34 (c)	Change 1: Make flowers/petals of different sizes or use coloured cards of different sizes Change 2: Make number of drops of sweet-smelling substance on each flower the same.
35 (a)	Material C. Material C absorbed the least amount of water. The swimsuit will be lightest/ least heavy when the person is swimming/ The swimmer will not be weighed down by the water when swimming.
35 (b)	The material must be flexible so that the swimmer can move his limbs freely/ swim without the swimsuit restricting his movement. <u>OR</u> The material must be elastic so there is less water resistance while swimming.
36 (a)	Evaporation is the process whereby matter changes state from liquid to gas.
36 (b)	Any value from 81 to 99
36 (c)	The temperature of water is lower in Container A so less water evaporates/ rate of evaporation of water is lower.
36 (d)	0 min. The temperature of the wet clothes is the highest so the water in the wet clothes will evaporate the fastest.
37 (a)	Gravitational force/gravity, elastic spring force and frictional force/friction (Any 2)
37 (b)	Spring Y. Spring Y is the stiffest spring / Spring Y extends the least when the same weight is added. Hence distance, d, will be the greatest.
38 (a)	A bar graph of similar height should be drawn.
38 (b)	Force: Push from the wind/Jack's blow Explanation: causes the bubble to float (a distance) in the air / causes the bubble to move in a certain/one direction Force: Air resistance/friction with air Explanation: causes the bubble to float slowly/slows down the speed of the bubble Force: Friction with the ground Explanation: Causes bubble to hit the ground and bursts
39 (a) & (b)	
40 (a)	As variable X increases, the amount of gas collected increases until (variable X is) 10 units, after which the amount of gas collected remains the same.
40 (b)	Variable X: number of water plants/ amount of carbon dioxide in the water/ intensity of light from the lamp
40 (c)	There will be more water plants/carbon dioxide/light trapped to make more food and produce more oxygen.
40 (d)	There is insufficient carbon dioxide/ light for the plants to make more food. <u>OR</u> The plant is photosynthesising at its maximum rate after that.
41 (a)	Kinetic → Electrical → Light
41 (b)	The bulbs will be dimmer. As Harry pedalled slower, less kinetic energy in his legs is transferred to the pedals. Less kinetic energy in the pedals is converted to less electrical energy produced in the generator which will convert to less light energy in the bulbs.

